

FLOM Products Catalog

2022.VER. 9.0

High Precision Fluid Control Devices and Components

Pumps

Switching Valves

Degassing Units

Liquid Level Sensors

Tube Reactors

OEM Products

Tubing

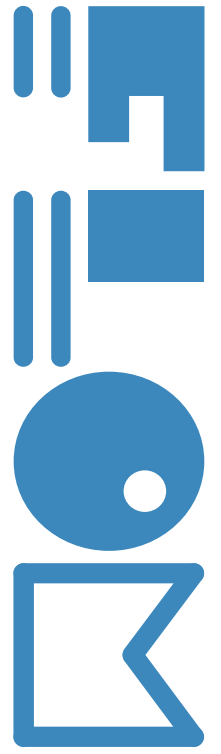

Message to Our Customers

Inception	<p>Our company started in October 1990 as a developer and manufacturer of components for liquid flow control, particularly as it applied to liquid chromatography. At first we focused on supplying the large OEMs involved in analytical instrumentation with high-pressure valves and related products.</p>
Growth	<p>The next year we began selling our GASTORR line of super-compact, high performance degassing systems to the OEM, general, and overseas markets. In 1992 we reached another milestone with the development of the super-compact non-pulsatile feedback control pump. We were highly gratified to see this pump, embodying a revolutionary feedback system, become a major hit, widely used in a multitude of analytical applications.</p>
Expansion	<p>We have introduced many new products to the market since our inception, and in every instance we have focused on our core mission as a component maker, always striving to develop and manufacture products with ever higher performance and quality. As part of our international sales efforts, we aggressively market our components in the US, Europe, Australia, and many parts of Asia, exhibiting not only at Pittcon, the world's largest analytical fair, but in many other venues throughout the world as well. And every year we announce and demo our latest creations to manufacturers and distributors throughout the industrialized world.</p>
Our Mission	<p>Current analytical applications demand not only ever higher performance and precision, but also products with minimal environmental impact (which includes resource recycling). In line with these new realities, we at FLOM have rededicated ourselves to providing high performance, compact, light, and low cost components that amply comply with the latest environmental regulations and recycling initiatives. As good corporate citizens we take pride in developing new products that contribute to the growth of the analytical market, and to the greater benefit of human society as well.</p>

FLOM Corporation

Table of Contents

1. Plunger Pumps	Selection Guide for Plunger Pumps.....	P1
	About the Switching Delivery Pump DP-11.....	P2
	Switching Delivery Pump DP-11.....	P3
	About the Micro Pump MP-22.....	P4
	Intelligent Micro Pump MP-22.....	P5
	Roller Pump WP-21.....	P5
	Plunger Pump Design and Features.....	P6
	Linear Drive Pulse Control Intelligent Pump UI-22 Series.....	P7
	Auto Back Pressure Regulator BP-11 Series (for MP-22 and UI-22).....	P7
	Dual Plunger Pump KP Series.....	P8
	Single Plunger Pump PCS SP Series.....	P9
	Pump Accessories.....	P10
2. Valves	Selection Guide for Valves.....	P11
	Types of Switching Valves.....	P12
	Auto Valve VA-21 Series.....	P13
	Manual Sample Injector VI Series.....	P14
	Ultra High Pressure: UHPLC Micro Injector MI-11.....	P14
	Manual Valves.....	P15
	Compact Manual Valves.....	P15
3. Degassing Units	Gastorr AG Series.....	P16
	Gastorr BG Series.....	P16
	Gastorr FG-42.....	P17
	Gastorr PG Series for Solvent Fractions.....	P17
4. Reservoir Sensor	Level Sensing Sonic Reservoir Sensor SR-13.....	P18
5. Reactors	Reactor RT Series.....	P19
6. OEM Products	Switching Delivery Pump DP-11.....	P20
	Intelligent Pump UI-22 Series.....	P21
	Degassing Unit Gastorr AG / BG Series.....	P21
	Auto Valve VA-21A Series	P22
	Auto Valve VF-02 Series.....	P23
	Air Valve 415 Series	P23
7. Tubing and Fittings	SUS Fittings	P24
	SUS Unions, Joints, Tubing.....	P25
	PEEK Fittings	P26
	Other Plastic Fittings.....	P27
	Polymer Unions and Joints.....	P29
	ETFE Fittings.....	P30
	PEEK , PTFE , ETFE , PFA Tubing.....	P31
8. Other Components	Filters.....	P32
	Solvent Bottles, Tube Cutters.....	P33
Glossary of Materials	P34

Note: The specifications and product design may change without prior notice. Due to continual product improvement, the photos and illustrations in this catalog may not match the current appearance of the products described herein. Contact your FLOM sales representative or distributor for information about special order products, which are not listed in this catalog.

1. Plunger Pumps

Selection Guide for Plunger Pumps

FLOM features a full lineup of plunger pumps for a wide variety of flow control systems and flow volume ranges. Depending on your application and goals, choose SUS, PEEK, or PCTFE as your pumphead material.

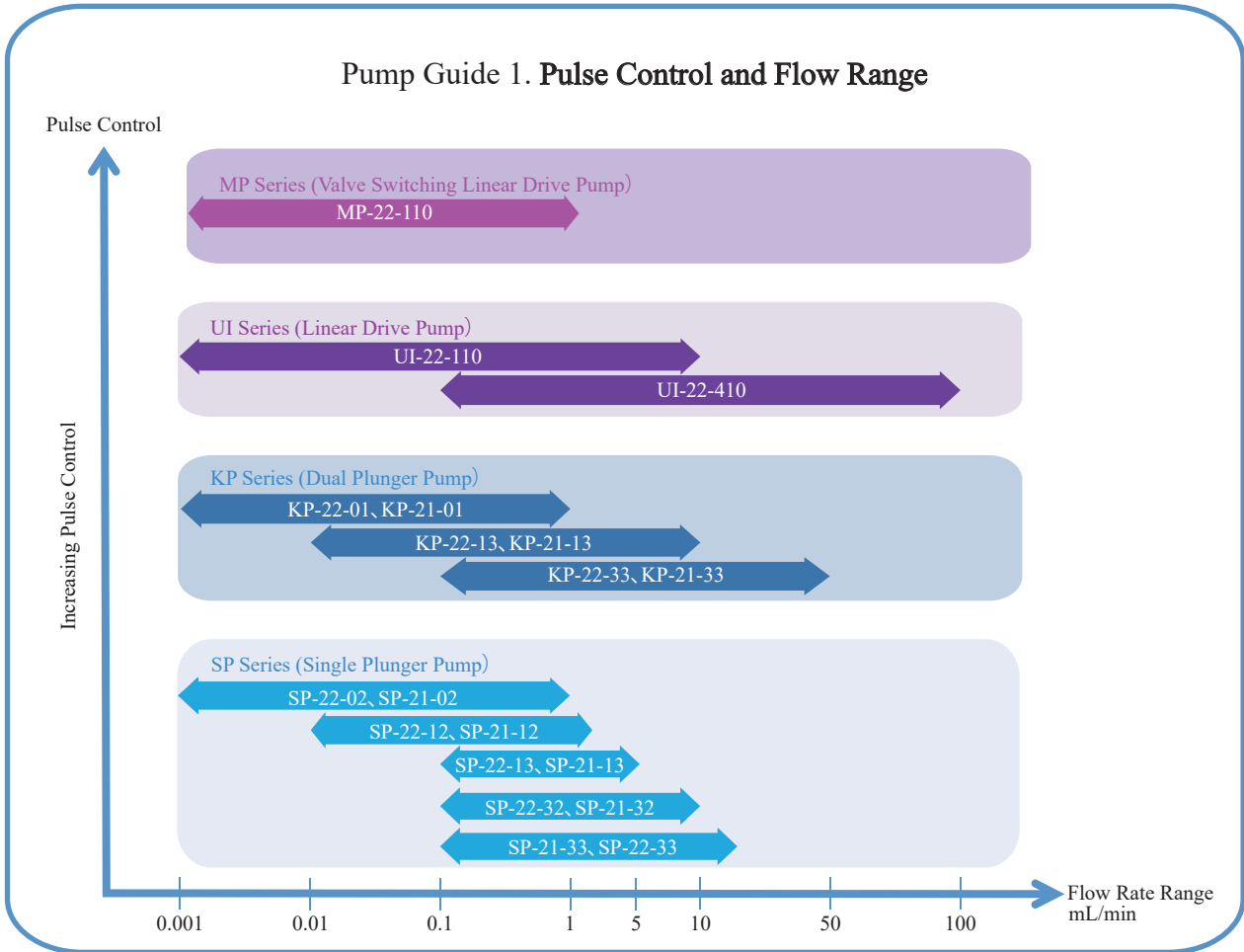

Pump Guide 2. Pumphead Material

Material	PCTFE	PEEK	SUS
Max Pressure	2 MPa (290 psi)	5~20 MPa* ¹ (725 ~ 2900 psi)	5 ~ 35 MPa* ¹ (725 ~ 5075 psi)
AVOID use with	<ul style="list-style-type: none"> tetrahydrofuran halogenated solutions under high temp 	<ul style="list-style-type: none"> tetrahydrofuran halogenated solutions strong acids 	<ul style="list-style-type: none"> strong acids certain inorganic salts

*¹: depends on device

About the Switching Delivery Pump DP-11

A new conception in multi-purpose pumps from FLOM.

This smart pump can either dispense up to 5 separate channels, or continuously dispense just 1 channel, all in one device.



What This Pump Can Do!

The DP-11 reliably dispenses to any channels you choose.

Volume
mL

Flow Rate
mL / min

Direction
Suction
Discharge

Simple Operation!
Start operation using the menu on the front panel.
You can even make fine adjustments to the piston movement remotely.

Aspirate from one port, and then dispense to another selected port on the fly. The reverse is also possible: select any port on the fly to send flow to one port.

• Special Features of the DP-11

High Flow Accuracy	<p>Accuracy : $\pm 1.0\%$ or ± 0.01 mL Repeatability : $\pm 0.1\%$ RSD or 0.00 1mL SD (Measuring Mode)</p> <p>The DP-11 offers high accuracy flow in both continuous flow and Measuring modes.</p>	Chemical Resistance	<p>Ceramic and PCTFE Chosen for the Wetted Materials</p> <p>High resistance with a wide range of liquids including strong acid</p>
Fewer Maintenance Problems	<p>NO CHECK VALVES!</p> <p>This avoids the typical problems you get when pumping highly viscous liquids.</p>	Rugged	<p>Uses FLOM's Proven Linear Drive!</p> <p>A smaller mechanical load reduces maintenance frequency.</p>

• For more detailed info on the DP-11, check out the video below.



QR Code Here↑



Switching Delivery Pump
DP-11



Switching Delivery Pump DP-11

A single unit controlling high accuracy flow in multiple flow paths and useful in combined pump/valve applications

Features

- Check valve-less design
- Can set flow to multiple paths
- High chemical resistance
- High accuracy flow volume
- Superior reliability
- Remote control thru RS232C communication

Product Name		Switching Delivery Pump
Part Number		DP-11
Pump Mechanism		Concentric Revolving Control Piston/Reciprocating Method
Pump Flow Modes		Measuring mode, Continuous flow mode, One-shot flow mode ※when remote controlled
Ports		6
Measuring Volume Settings		0.001 ~ 9.999 mL 0.01 ~ 99.99 mL 0.1 ~ 999.9 mL 1 ~ 9999 mL any of the above selectable 0.001 ~ 9999.999mL ※when remote controlled
Flow Rate Settings	Continuous flow	0.1 ~ 10.0 mL/min (8 mm stroke) 0.1 ~ 6.0 mL/min (4 mm stroke)
	One-shot flow	0.1 ~ 25.0 mL/min ※when remote controlled
Maximum Pressure		0.5 MPa or less
Volume per Stroke		300 μ L (8 mm stroke)
Measuring Mode	Accuracy	$\pm 1.0\%$ or ± 0.01 mL or less, whichever is greater* ¹
	Repeatability	0.1 % RSD or 0.001 mL SD or less, whichever is greater* ¹
Continuous flow Mode	Accuracy	$\pm 2.0\%$ or less, only when pumping 1 mL/min or higher* ²
	Repeatability	0.1 % RSD or 0.005 minutes SD or less, whichever is greater* ²
Special Functions		Variable piston stroke (8 mm / 4 mm) Piston quick movement (suction / discharge) Flow volume correction
Port Type		1/4-28 UNF
Connecting Tube Diameters		1/8", 3.0 mm, 2.0 mm, 1/16"
Wetted Materials		Ceramic, PCTFE, PTFE, FFKM
Remote Control Signals		Measuring: start measuring, end measuring Continuous flow: start continuous, error either one of the above sets
Communication		RS232C, RS485 (between FLOM devices)
Dimensions		144 (H) \times 79 (W) \times 240 (D) mm, excluding protuberances
Weight		Approx. 2.4 kg
Power		AC 100 ~ 240 V (50 / 60 Hz), MAX 80 VA
Order Code		SSD-F022

*1: Pure water : Pump Pressure \approx 0.0MPa

*2: Methanol : Pump Pressure \approx 0.0MPa

DP-11 Optional Accessories

P/N	Product Name	Notes
9823D	1/8" Flat Seal Fitting D (10/Pack)	For OD 3.0 mm, 1/8" tubing
9707	1/8" M6 Flat Seal Ferrule (10/Pack)	For OD 1/8" tubing
9704	3.0 mm M6 Flat Seal Ferrule (10/Pack)	For OD 3.0 mm tubing
9773	1/16" HEX Flat Seal Fitting (10/Pack)	For OD 1/16" tubing
9706	1/16" M6 Flat Seal Ferrule (10/Pack)	For OD 1/16" tubing
8810	Suction Filter	For OD 3.0 mm, 1/8" tubing
8811	Suction Filter	For OD 1/16" tubing
2710	1/4" Seal Plug (4/pack)	DP-11 Stop plug

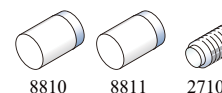
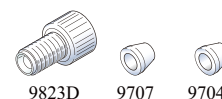

About the Micro Pump MP-22

Instead of using check valves, the Micro Pump MP-22 uses switching valves and a linear drive pump, resulting in a stable flow even at extremely low flow rates. Comes equipped with an auto-priming feature that primes with just a push of a button.

• MP-22 Design

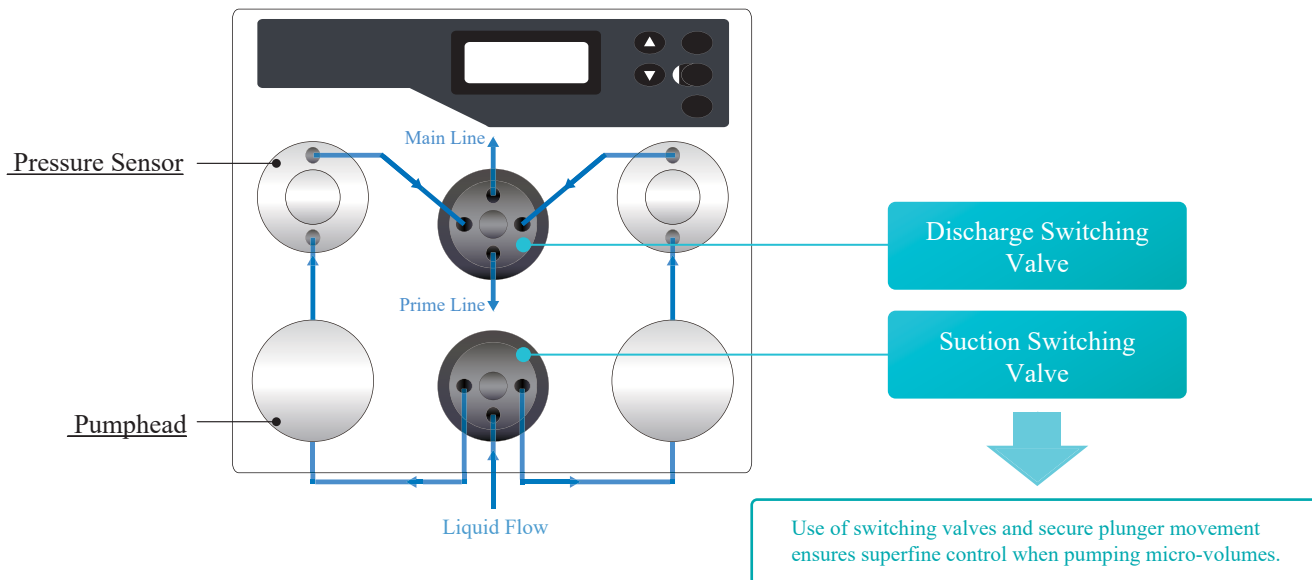

• MP-22 4 Special Features

**Low-pulse
Continuous
Flow**

Switching Valves + Linear Drive Pump

FLOM's unique design concept reduces pulsing to an absolute minimum.

**Reduced
Maintenance**

Designed without Check Valves!

Reliable, stable flow at low flow rates.

**Simple
Setup**

Auto-Prime Function

A single press of the PRIME button will automatically bleed air and start prep flow.

**High
Pressure
Resistance**

Maximum Pressure 35MPa (5075 psi)

The greatest advantage of the plunger pump is its reliable, continuous flow at high pressures.

• MP-22 Flow Stability

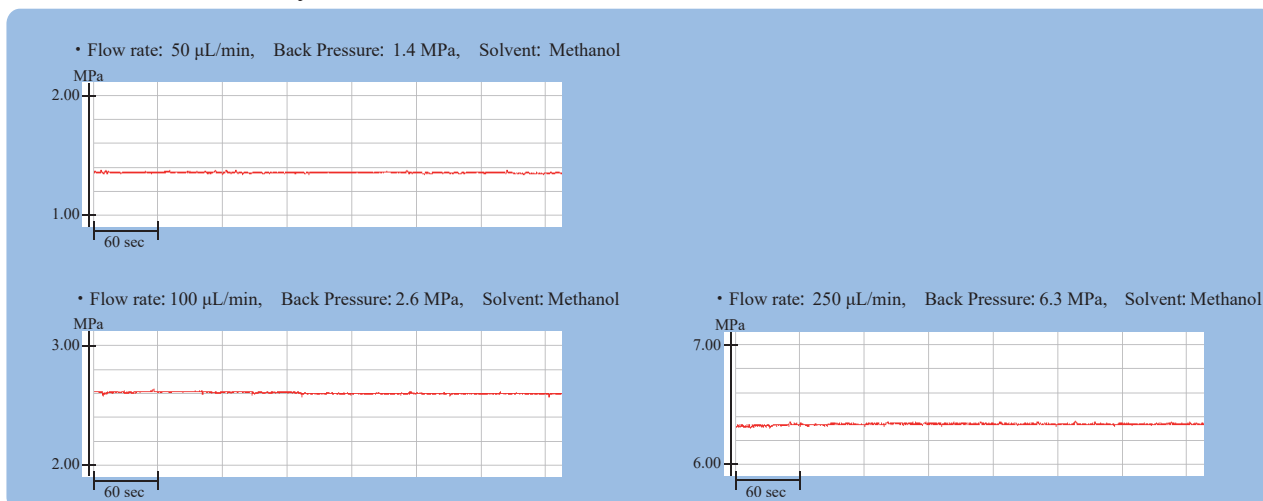



Intelligent Micro Pump
MP-22-110S

Valve Switching Micro Pump MP-22 Intelligent Micro Pump MP-22

Uses FLOM's unique configuration of switching valves and a linear drive pump

Features

- Improved near-zero pulse flow
- Problems with bubbles greatly reduced
- Simplified setup
- Upper and lower pressure limiters
- Space-saving compact design
- Remote control

Product name	Intelligent Micro Pump
Part number	MP-22-110S
Pumphead material	SUS
Max Pressure* ¹	35 MPa (5075 psi)
Flow rate range* ²	0.1 ~ 999.9 μ L/min
Flow per stroke	80 μ L
Plunger stroke	10 mm
Flow repeatability* ³	< 0.3 %
Flow rate accuracy* ⁴	\pm 2% or \pm 0.2 μ L /min or less, whichever is greater
Features	Self-regulating, Upper/lower pressure limiters
Pressure accuracy	\pm 0.2 MPa (\pm 29 psi)
Wetted materials	Sapphire, PFA, FFKM, UHMW-PE, PEEK, SUS
Remote control	Input: PUMP ON / OFF , Output: Error, Pressure Monitor
Communication	RS232C , RS485 (between FLOM devices)
Dimensions	150 (H) \times 160 (W) \times 280 (D) mm, excluding protuberances
Weight	Approx. 6.7 kg
Power	AC100 ~ 240 V (50 / 60 Hz) MAX 200 VA
Order Code	SMP-P505

*1: Maximum pressure is only sustained intermittently.

*2: Maximum flow rate is not sustainable over long periods of time.

*3: Solvent methanol at flow rate 10~500 μ L/min , back pressure > 145 ~ 2900 psi

*4: Test data generated under FLOM's standard test conditions.

Roller Pump Roller Pump WP-21

Great for plunger pump cleaning and basic pumping applications

Features

- Choose tubing to match your solvent
- Tube cassette can be set in any of 4 directions
- Space-saving compact design

Product name	Roller Pump
Part number	WP-21
Flow rate range	Approx. 0.5, 1.0, 2.0, 3.0 mL/Min. (4 step settings in rotary style)
Features	hold down front switch to purge (approx. 5mL/min)
Flow rate accuracy	\pm 5 % (fresh Pharmed BPT* ¹)
Max pressure	90 kpa or less (Pharmed BPT* ¹)
Intake pressure	-90 kpa or less (Pharmed BPT* ¹)
Liquid temperature range	5 ~ 50 $^{\circ}$ C
Rotary direction	Clockwise when viewed from front
Remote control	Input: OFF/ ON switch Output: error output from open collector
Tubing	Pharmed BPT* ¹ / Fluran F-5500-A / TransMaster TM-15
Dimensions	65 (H) \times 46 (W) \times 110 (D) mm, excluding protuberances
Weight	Approx. 0.5 kg
Power	DC 24 V, MAX 15 W (AC adapter included)
Order code	SWP-F021

*1: "Pharmed BPT" is a registered trademark of Saint-Gobain, S.A.

* Product comes with Pharmed BPT tubing standard.

Please contact us if you prefer Fluran F-5500-A or TransMaster TM-15 tubing.

* Pumping action begins automatically as soon as the power is turned on.



Roller Pump
WP-21



Pharmed BPT
(standard)



Fluran F-5500-A
(sold separately)



TransMaster TM-15
(sold separately)

Plunger Pump Design and Features

FLOM Plunger Pumps come in two configurations: linear drive and cam drive.

Linear Drive (UI Series)

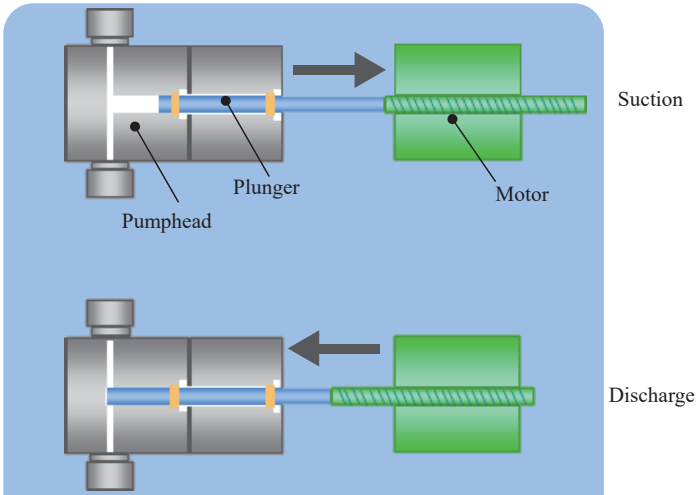

In a linear drive, the plunger moves along the same axis as the motor. In the graph above, the plunger moves left/right.

Left and right pumpheads are independently controlled.
The plunger stroke is about 2.5 times longer than in a cam drive, producing much more powerful suction and discharge actions.

Cam Drive (KP, SP Series)

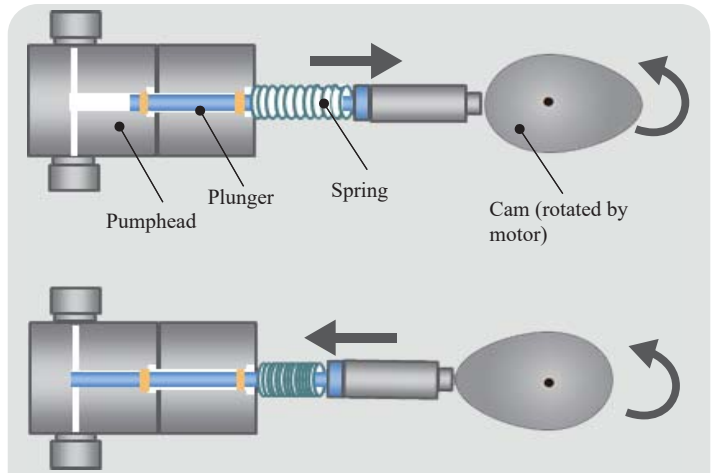

In this design, a cam translates the circular motion of the motor into linear motion. This linear motion powers plunger movement and also loads the spring for the return motion.

1 motor can be used to power 2 plungers in this case, but the cam's rotary action can cause the plungers to wobble up and down (thus there is a limit to stroke length).

● Response to air injection

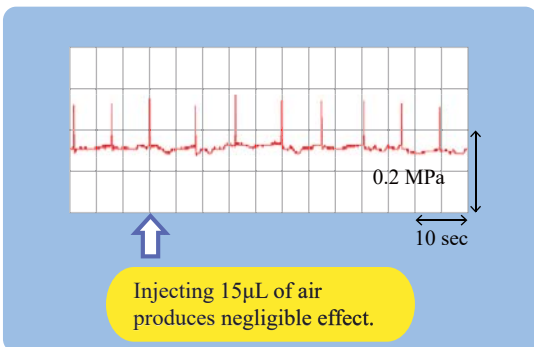

✦ Since right and left pumpheads are controlled separately, their output is stable even with the injection of air.

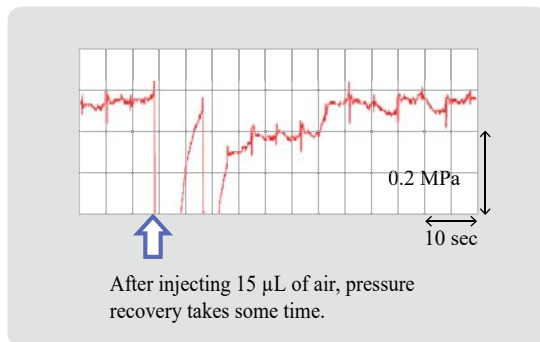

● UI-22 Series Flow Stability

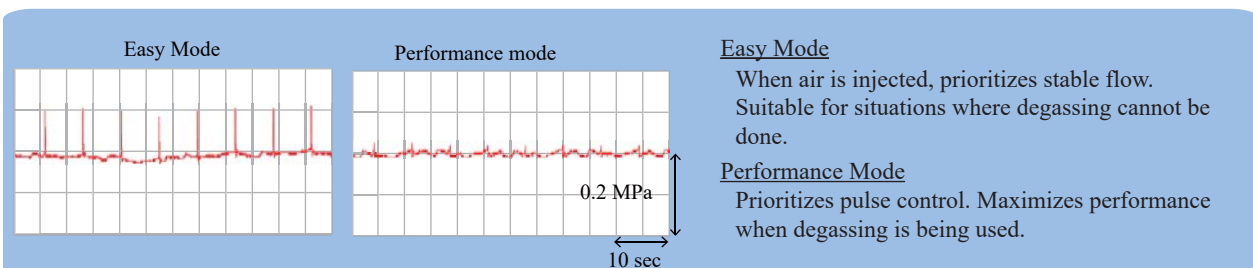

Linear Drive Pulse Control Intelligent Pump

Intelligent Pump UI-22 Series

Combines high precision flow and ease of use

Features

- Pulses reduced to absolute minimum making low flow rate pumping possible
- Bubble problems greatly reduced
- Long life plunger seal
- Upper and lower pressure limiters
- Space-saving compact design
- Control with RS232C protocol
- Choose SUS, PEEK, or PCTFE to fit your solvent

Intelligent Pump
UI-22-110SIntelligent Pump
UI-22-110PIntelligent Pump
UI-22-110D

Product name	Intelligent Pump					
Part number	UI-22-110S	UI-22-110P	UI-22-110D	UI-22-410S	UI-22-410P	UI-22-410D
Pumphead material	SUS	PEEK	PCTFE	SUS	PEEK	PCTFE
Max pressure*1	35 MPa (5075 psi)	20 MPa (2900 psi)	2 MPa (290 psi)	5 MPa (725 psi)	5 MPa (725 psi)	2 MPa (290 psi)
Flow rate range*2	0.001~9.999 mL/min			0.01 ~ 99.99 mL/min		
Flow per stroke	80 μ L			708 μ L		
Plunger stroke	10 mm					
Flow repeatability*3	< 0.3 % (0.1 ~ 5.0 mL/min)			< 0.3 % (1.0 ~ 50 mL/min)		
Flow accuracy*3	\pm 2% or \pm 2 μ L /min or less, whichever is greater			\pm 2% or \pm 20 μ L /min or less, whichever is greater		
Features	Self-regulating, upper/lower pressure limiters					
Pressure accuracy	\pm 0.2 MPa					
Wetted materials	SUS: Sapphire, Ruby, PCTFE, PFA, FFKM, UHMW-PE, PEEK, SUS					
	PEEK: Sapphire, Ruby, PCTFE, PFA, FFKM, UHMW-PE, PEEK, ETFE					
	PCTFE: Sapphire, Ruby, PCTFE, PFA, FFKM, ETFE, PTFE					
Remote control	Input: PUMP ON / OFF, Output: Error signal, Pressure monitor					
Communication	RS232C, RS485 (between FLOM devices)					
Dimensions	144 (H) \times 105 (W) \times 240 (D) mm, excluding protuberances					
Weight	Approx. 5.6 kg					
Power	AC100~240 V (50 / 60 Hz) MAX140 VA					
Order Code	SLP-P509	SLP-P514	SLP-P517	SLP-P511	SLP-P516	SLP-P510

*1: Maximum pressure is only sustained intermittently, this does not mean maximum pressure under continuous use.

*2: Maximum output is not sustainable over long periods of time,

*3: Test data generated under FLOM's standard test conditions.

Auto Back Pressure Regulator for MP-22 and UI-22 Series

Auto BPR BP-11 Series

Automatic pressure regulation for changes due to factors such as temperature and flow fluctuations

Features

- Provide consistent pressure by tracking variable pump pressure in real time
- MP-22 and UI-22 Series provide stable flow, BP-11 Series maintains set pressure

Auto BPR
BP-11S

Product name	Auto BPR	
Part number	BP-11S	BP-11D
Wetted materials	SUS, PFA	PCTFE, PFA
Path diameter	0.6 mm	
Setup pressure range	0.10 ~ 5.00 MPa (14.5 ~ 725 psi)	
Flow rate range	0.1 ~ 100 mL/min	
Features	Manual mode, Auto-stop	
Pressure accuracy*1	\pm 0.1 MPa (\pm 14.5 psi)	
Pressure signal range	Uses pressure signal from MP-22/UI-22 [DC1 - 5V]	
Remote control	Input: Start/Stop, Output: FUNC RS232C, RS485 (between FLOM devices)	
Dimensions	144 (H) \times 79 (W) \times 240 (D) mm, excluding protuberances	
Weight	Approx. 2.7 kg	
Power	AC100 ~ 240 V (50 / 60 Hz) MAX 70 VA	
Order Code	SBP-F012	SBP-F019

*1: Using pure water or methanol, pressure 0.5 ~ 5.0 MPa / flow rate 0.1 ~ 50.0 mL/min.

※: please contact us if you need flow rates outside 0.1 ~ 50 mL/min.

Dual Pump
KP-22-13SDual Pump
KP-22-13P

Dual Plunger Pump Dual Pump KP-22 Series

A cam drive pump with pressure sensor

Features

- Cam-driven design with high flow repeatability and low pulsing
- Pressure sensor allows setting upper/lower limits
- 6 separate configurations of flow range/pumphead material
- RS232C control protocol

Product name	Dual Pump (with pressure sensor)					
Part number	KP-22-01S	KP-22-01P	KP-22-13S	KP-22-13P	KP-22-33S	KP-22-33P
Pumphead material	SUS	PEEK	SUS	PEEK	SUS	PEEK
Max pressure*1	25 MPa (3625 psi)	20 MPa (2900 psi)	25 MPa (3625 psi)	20 MPa (2900 psi)	5 MPa (725 psi)	5 MPa (725 psi)
Flow rate range*2	0.001 ~ 1.000 mL/min		0.01 ~ 10.00 mL/min		0.1 ~ 50.0 mL/min	
Flow per stroke	4 µL		32 µL		154 µL	
Plunger stroke	1 mm		4 mm		4 mm	
Flow repeatability	< 0.3 %					
Features	Pulse control*3, Set pressure*4, Set volume dispensing*5, Upper/lower pressure limiters*6					
Pressure accuracy	±0.2 MPa					
Wetted Material	SUS: Sapphire, Ruby, PCTFE, PFA, FFKM, UHMW-PE, PEEK, SUS PEEK: Sapphire, Ruby, PCTFE, PFA, FFKM, UHMW-PE, PEEK, ETFE					
Remote control	Input: PUMP ON / OFF, Output: Error					
Communication	RS232C					
Dimensions	144 (H) × 79 (W) × 285 (D) mm, excluding protuberances					
Weight	Approx. 4.3 kg					
Power	AC 100 ~ 240 V (50 / 60 Hz) MAX 80 VA					
Order Code	SDP-P1081	SDP-P1080	SDP-P1077	SDP-P1076	SDP-P1079	SDP-P1078

*1: Maximum pressure is only sustained intermittently. This does not mean that maximum pressure can be habitually maintained at max flow rate.

*2: The unit cannot run continuously at maximum flow rate.

*3: Pulse control is based on cam rotary compensation, activated below a flow pressure of 5 MPa.

*4: Set pressure mode adjusts the flow rate in real time to stabilize pressure. It uses the average of measured pressure.

*5: In set volume mode, when the set volume has been dispensed, pumping automatically stops.

*6: The lower pressure limiter can only be set by RS232C remote control.

Dual Pump
KP-21-13SDual Pump
KP-21-13P

Dual Plunger Pump Dual Pump KP-21 Series

A cam drive pump without pressure sensor

Features

- Cam-driven design with high flow repeatability and low pulsing
- Reasonable price without equipping pressure sensor
- 6 separate configurations of flow range/pumphead material
- RS232C control protocol

Product name	Dual Pump (without pressure sensor)					
Part number	KP-21-01S	KP-21-01P	KP-21-13S	KP-21-13P	KP-21-33S	KP-21-33P
Pumphead material	SUS	PEEK	SUS	PEEK	SUS	PEEK
Max pressure*1	25 MPa (3625 psi)	20 MPa (2900 psi)	25 MPa (3625 psi)	20 MPa (2900 psi)	5 MPa (725 psi)	5 MPa (725 psi)
Flow rate range*2	0.001 ~ 1.000 mL/min		0.01 ~ 10.00 mL/min		0.1 ~ 50.0 mL/min	
Flow per stroke	4 µL		32 µL		154 µL	
Plunger stroke	1 mm		4 mm		4 mm	
Flow repeatability	< 0.3 %					
Features	Set volume dispensing*3					
Pressure accuracy	—					
Wetted Material	SUS: Sapphire, Ruby, PCTFE, FFKM, UHMW-PE, PEEK, SUS PEEK: Sapphire, Ruby, PCTFE, PFA, FFKM, UHMW-PE, PEEK, ETFE					
Remote control	Input: PUMP ON / OFF, Output: Error					
Communication	RS232C					
Dimensions	144 (H) × 79 (W) × 285 (D) mm, excluding protuberances					
Weight	Approx. 4.3 kg					
Power	AC 100 ~ 240 V (50 / 60 Hz) MAX 80 VA					
Order Code	SDP-P1087	SDP-P1086	SDP-P1083	SDP-P1082	SDP-P1085	SDP-P1084

*1: Maximum pressure is only sustained intermittently. This does not mean that maximum pressure can be habitually maintained at max flow rate.

*2: The unit cannot run continuously at maximum flow rate.

*3: In set volume mode, when the set volume has been dispensed, pumping automatically stops.

PCS Pump
SP-22-13SPCS Pump
SP-22-13P

Single Plunger Pump PCS Pump SP-22 Series

Single plunger pump equipped with pressure sensor

Features

- Uses proven cam-driven pump action
- Can choose Quick Return mode for Pulse Control
- Pressure sensor allows setting upper limit
- 10 separate configurations of flow range/pumphead material
- RS232C control protocol

Product name	PCS Pump (with pressure sensor)									
Part number	SP-22-02S	SP-22-02P	SP-22-12S	SP-22-12P	SP-22-13S	SP-22-13P	SP-22-32S	SP-22-32P	SP-22-33S	SP-22-33P
Pumphead material	SUS	PEEK	SUS	PEEK	SUS	PEEK	SUS	PEEK	SUS	PEEK
Max pressure*1	20 MPa (2900 psi)		20 MPa (2900 psi)		10 MPa (1450 psi)		5 MPa (725psi)		2 MPa (290 psi)	
Flow rate range*2	0.001 ~ 1.000 mL/min		0.01 ~ 2.00 mL/min		0.1 ~ 5.0 mL/min		0.1 ~ 10.0 mL/min		0.1 ~ 20.0 mL/min	
Flow per stroke	8 μ L		16 μ L		32 μ L		77 μ L		154 μ L	
Plunger stroke	2 mm		2 mm		4 mm		2 mm		4 mm	
Flow Repeatability	$\pm 0.5\%$									
Features	Pulse control, Set volume dispensing*3, Upper pressure limiters									
Pressure accuracy	± 0.2 MPa									
Wetted Material	SUS: Sapphire, Ruby, PCTFE, PFA, FFKM, UHMW-PE, SUS PEEK: Sapphire, Ruby, PCTFE, PFA, FFKM, UHMW-PE, PEEK									
Remote control	Input: PUMP ON / OFF, Output: Error									
Communication	RS232C									
Dimensions	144 (H) \times 79 (W) \times 285 (D) mm, excluding protuberances									
Weight	Approx. 3.0 kg									
Power	AC 100 ~ 240 V (50 / 60 Hz) MAX 80 VA									
Order Code	SSP-P3062	SSP-P3061	SSP-P3064	SSP-P3063	SSP-P3066	SSP-P3065	SSP-P3068	SSP-P3067	SSP-P3070	SSP-P3069

*1: Maximum pressure is only sustained intermittently. This does not mean that maximum pressure can be habitually maintained at max flow rate.

*2: The unit cannot run continuously at maximum flow rate.

*3: In set volume mode, when the set volume has been dispensed, pumping automatically stops.

PCS Pump
SP-21-13SPCS Pump
SP-21-13P

Single Plunger Pump PCS Pump SP-21 Series

Single plunger pump without pressure sensor

Features

- Uses proven cam-driven pump action
- Can choose Quick Return mode for Pulse Control
- Reasonable price without equipping pressure sensor
- 10 separate configurations of flow range/pumphead material
- RS232C control protocol

Product name	PCS Pump (without pressure sensor)									
Part number	SP-21-02S	SP-21-02P	SP-21-12S	SP-21-12P	SP-21-13S	SP-21-13P	SP-21-32S	SP-21-32P	SP-21-33S	SP-21-33P
Pumphead material	SUS	PEEK	SUS	PEEK	SUS	PEEK	SUS	PEEK	SUS	PEEK
Max pressure*1	20 MPa (2900 psi)		20 MPa (2900 psi)		10 MPa (1450 psi)		5 MPa (725psi)		2 MPa (290 psi)	
Flow rate range*2	0.001 ~ 1.000 mL/min		0.01 ~ 2.00 mL/min		0.1 ~ 5.0 mL/min		0.1 ~ 10.0 mL/min		0.1 ~ 20.0 mL/min	
Flow per stroke	8 μ L		16 μ L		32 μ L		77 μ L		154 μ L	
Plunger Stroke	2 mm		2 mm		4 mm		2 mm		4 mm	
Flow Repeatability	$\pm 0.5\%$									
Features	Pulse control, Set volume dispensing*3									
Pressure accuracy	—									
Wetted Material	SUS: Sapphire, Ruby, PCTFE, PFA, FFKM, UHMW-PE, SUS PEEK: Sapphire, Ruby, PCTFE, PFA, FFKM, UHMW-PE, PEEK									
Remote control	Input: PUMP ON / OFF, Output: Error									
Communication	RS232C									
Dimensions	144 (H) \times 79 (W) \times 285 (D) mm, excluding protuberances									
Weight	Approx. 3.0 kg									
Power	AC100 ~ 240 V (50 / 60 Hz) MAX 80 VA									
Order Code	SSP-P3052	SSP-P3051	SSP-P3054	SSP-P3053	SSP-P3056	SSP-P3055	SSP-P3058	SSP-P3057	SSP-P3060	SSP-P3059

*1: Maximum pressure is only sustained intermittently. This does not mean that maximum pressure can be habitually maintained at max flow rate.

*2: The unit cannot run continuously at maximum flow rate.

*3: In set volume mode, when the set volume has been dispensed, pumping automatically stops.

Pump Accessories



High Pressure Damper 9810



Low Pressure Damper 9800

Pulse Dampers

These pulse dampers will improve flow performance of single plunger pumps. Choose either high or low pressure type.

Product name	High Pressure Damper	Low Pressure Damper
Part number	9810	9800
Max pressure	20 MPa (2900 psi)	2 MPa (290 psi)
Pulse control range	8 ~ 12 MPa (1160 ~ 1740 psi)	0.1 ~ 0.7 MPa (15 ~ 102 psi)
Internal volume	Approx 3.5 mL	Approx 0.8 mL
Wetted material	PEEK , PTFE	PEEK , FEP
Thread size	No.10-32 UNF	No.10-32 UNF
Dimensions	φ50 × 36.5 (H) mm	φ45 × 33 (H) mm
Weight	Approx 0.3 kg	Approx 0.3 kg
Order Code	PDM-F001	PDM-F002

Side Panels for Valve Attachment

For attachment of switch valves, sample injectors, and other accessories to pumps. Can be attached to all UI, KP, and SP type pumps.

Side Panel 4512
Injector TypeSide Panel 4513
Injector/Damper TypeSide Panel 4514
Compact Switching Valve Type

Product name	Side Panel		
Part number	4512	4513	4514
Pump type	UI-22, KP-2x, SP-2x Series		
Attachable parts	VI-11 , VI-12 , MI-11 , V05	VI-11 , VI-12 , MI-11 , V05	V200, V201, V204, V239, V512
Damper attachable	No	Yes	No
Dimensions	144 (H) × 60 (W) × 44 (D) mm, excluding protuberances		
Order code	PB1001-10	PB1001-09	PB1001-11

2. Valves

We at FLOM have many years' experience developing switching valves and injectors featuring a variety of materials and functionality. The trend in recent years has been to increase our line-up with more compact, high-pressure, wear-resistant products. If you don't see what you're looking for here, let us know what you want. We can probably design a product that fits your needs perfectly.

Selection Guide for Valves

FLOM valves come in 3 varieties of drive: manual, automatic, or pneumatic (air-driven).

Valve Types

Manual	Automatic		Pneumatic (Anti-explosive)
	Stand-alone	OEM	
VI Series (Injector) MI-11 (Ultra high pressure injector) V Series (Switching valves)	VA-21 Series (high pressure, long life, non-metallic, high volume)	VA-21A Series (Standard speed switching) VF-02 Series (High speed switching)	415 Series

Type of Valve Heads (Examples)

4-port switching 	6-port switching 	16-port switching 
2-way 3-port switching 	2-way 4-port switching 	4-port rotary 
6-port rotary 	8-port rotary 	12-port rotary 

Types of Switching Valves

These are only a few typical designs – there are many others. If you don't find the configuration you're looking for here, please contact us for more options.

VALVE UNIT

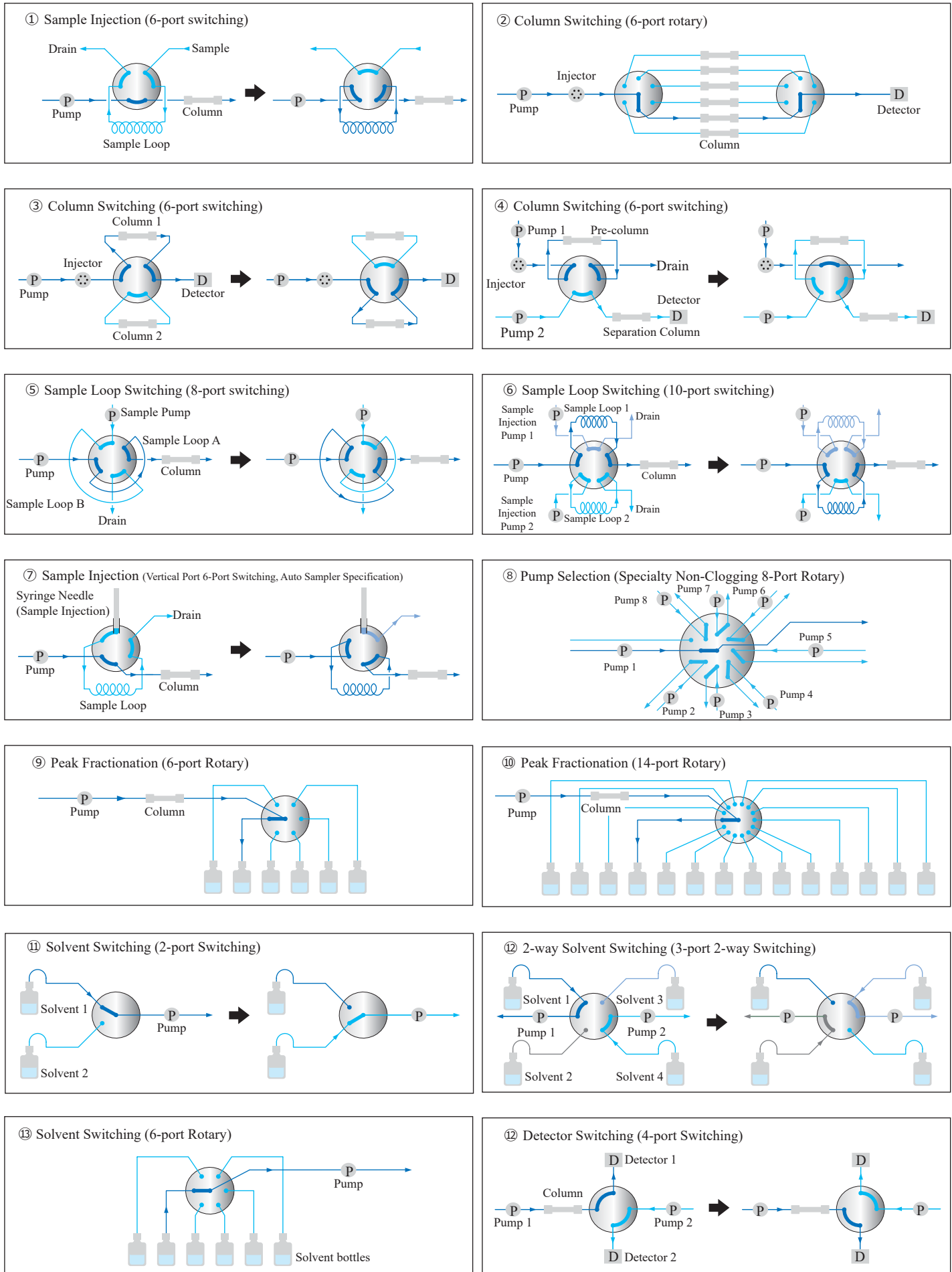



Auto Valve Unit VA-21

Automatic Switching Valves Auto Valve Unit VA-21 series

For general, high speed, and fraction analysis, choose the flow paths you need to cover a wide variety of applications

Features

- Pick the valve type that fits your application
- Featuring high flow and non-metallic types
- Long valve life based on FLOM technology

Valve Drive

Product Name	Automatic Switching Valve
Product Number	VA-21
Drive	DC gear motor drive
Switching Modes	2 position switching, rotary
Manual Input	Position change, position reset
Remote Control	Input: position change / set / reset Output: position, error
Communication	RS232C, RS485 (between FLOM devices)
Power	DC 24 V, MAX 50 W (AC adapter standard)
Dimensions	116 (H) × 66 (W) × 200 (D) mm, excluding protuberances
Weight	Approx. 2.0 kg

Valveheads (Consult FLOM for valvehead types not on this list)

P/N	Type	Path Position	Max Pressure	Wetted Material	Tube OD	Thread Size	Path Diameter	Order Code
VA-21-601	6 Port 2 position		40 MPa (5800 psi)	SUS, PEEK	1/16"	No.10-32UNF	0.25 mm (0.01")	SAV-VA-21-601
VA-21-602			30 MPa (4350 psi)	PEEK Ceramic	1/16"	No.10-32UNF	0.25 mm (0.01")	SAV-VA-21-602
VA-21-603			40 MPa (5800 psi)	SUS, PEEK	1/16"	No.10-32UNF	0.5 mm (0.02")	SAV-VA-21-603
VA-21-604			30 MPa (4350 psi)	PEEK Ceramic	1/16"	No.10-32UNF	0.5 mm (0.02")	SAV-VA-21-604
VA-21-605			20 MPa (2900 psi)	SUS, PEEK	1/16"	No.10-32UNF	1.0 mm (0.04")	SAV-VA-21-605
VA-21-606			20 MPa (2900 psi)	PEEK Ceramic	1/16"	No.10-32UNF	1.0 mm (0.04")	SAV-VA-21-606
VA-21-607			5 MPa (725 psi)	SUS, PEEK	3.0 mm or 1/8"	M8×1.25	2.0 mm (0.079")	SAV-VA-21-607
VA-21-608			5 MPa (725 psi)	PEEK Ceramic	3.0 mm or 1/8"	M8×1.25	2.0 mm (0.079")	SAV-VA-21-608
VA-21-609	4 Port 2 position		40 MPa (5800 psi)	SUS, PEEK	1/16"	No.10-32UNF	0.5 mm (0.02")	SAV-VA-21-609
VA-21-610			30 MPa (4350 psi)	PEEK Ceramic	1/16"	No.10-32UNF	0.5 mm (0.02")	SAV-VA-21-610
VA-21-611	1-2 Port (3-way valve)		40 MPa (5800 psi)	SUS, PEEK	1/16"	No.10-32UNF	0.5 mm (0.02")	SAV-VA-21-611
VA-21-612			30 MPa (4350 psi)	PEEK Ceramic	1/16"	No.10-32UNF	0.5 mm (0.02")	SAV-VA-21-612
VA-21-613			5 MPa (725 psi)	SUS, PEEK	3.0 mm or 1/8"	M8×1.25	2.0 mm (0.079")	SAV-VA-21-613
VA-21-614	5 MPa (725 psi)	PEEK Ceramic	3.0 mm or 1/8"	M8×1.25	2.0 mm (0.079")	SAV-VA-21-614		
VA-21-615	1-4 Port Rotary		40 MPa (5800 psi)	SUS, PEEK	1/16"	No.10-32UNF	0.5 mm (0.02")	SAV-VA-21-615
VA-21-616			30 MPa (4350 psi)	PEEK Ceramic	1/16"	No.10-32UNF	0.5 mm (0.02")	SAV-VA-21-616
VA-21-617	1-6 Port Rotary		40 MPa (5800 psi)	SUS, PEEK	1/16"	No.10-32UNF	0.5 mm (0.02")	SAV-VA-21-617
VA-21-618			30 MPa (4350 psi)	PEEK Ceramic	1/16"	No.10-32UNF	0.5 mm (0.02")	SAV-VA-21-618
VA-21-619			5 MPa (725 psi)	SUS, PEEK	3.0 mm or 1/8"	M8×1.25	2.0 mm (0.079")	SAV-VA-21-619
VA-21-620			5 MPa (725 psi)	PEEK Ceramic	3.0 mm or 1/8"	M8×1.25	2.0 mm (0.079")	SAV-VA-21-620
VA-21-621	1-12 Port Rotary		20 MPa (2900 psi)	SUS, PEEK	1/16"	No.10-32UNF	0.5 mm (0.02")	SAV-VA-21-621
VA-21-622			20 MPa (2900 psi)	PEEK Ceramic	1/16"	No.10-32UNF	0.5 mm (0.02")	SAV-VA-21-622
VA-21-623	8 Port		20 MPa (2900 psi)	SUS, PEEK	1/16"	No.10-32UNF	0.5 mm (0.02")	SAV-VA-21-623

VA-21 Optional Accessories

Part Number	Product Name
UF2100-01	VA-21 I/O Cable (Change / Reset only)
UF2100-02	RS232C Cable (for VA-21 only)
PF505-01	RS485 Cable
PF505-03	RS485 Extension Cable



Manual Injector VI-11



UHPLC Micro Injector MI-11

Manual Sample Injectors Manual Sample Injector VI Series

Features

- Choose Stainless Steel or PEEK for the fluid path
- Can output injection marker

Ultra High Pressure Manual Micro Injectors UHPLC Micro Injector MI-11

Features

- Ultra high-pressure spec allows sample injection into high pressure fluid pathways
- Ultra high precision minimizes sample loss
- Can output injection marker

Product name	Manual Sample Injector		
Part number	VI-11	VI-12	MI-11
Wetted materials	SUS, PEEK, Ceramic	PEEK, Ceramic	SUS, PEEK, Ceramic
Max Pressure	35 MPa (5,075 psi)	35 MPa (5,075 psi)	100 MPa (14,500psi)
Tube OD	1/16"	1/16"	1/16"
Path diameter	0.5 mm (0.02")	0.5 mm (0.02")	0.25 mm (0.01")
Port thread size	No. 10-32 UNF	No. 10-32 UNF	No. 10-32 UNF
Sample loop (standard)	20 µL (SUS)	20 µL (PEEK)	5 µL (SUS)
Injection marker	Built-in (1.5 m lead wire)		
Order code	VH-V271	VH-V276	VH-V340

Optional Accessories

SUS Sample Loops (Recommended for SUS Valveheads)



SUS, 20 µL

P/N	Volume
7501W	10 µL
7502W	20 µL
7503W	50 µL
7504W	100 µL
7505W	200 µL
7506W	500 µL
7507W	1 mL

PEEK Sample Loops (Recommended for PEEK Valveheads)

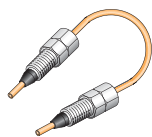

PEEK, 20 µL

P/N	Volume
7201	10 µL
7202	20 µL
7203	50 µL
7204	100 µL
7205	200 µL
7206	500 µL
7207	1 mL

MI-11 Sample Loop



MI-11 Sample Loop

P/N	Volume
7500M	5 µL

VI-11 • VI-12 Syringe Needles

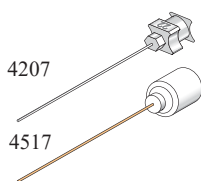

4207

4517

4701

P/N	Volume
4207	SUS22G*1
4517	PEEK*2
*1 ID	0.5 mm
*2 OD	0.7 mm x ID 0.3 mm

MI-11 Syringe



P/N	Volume
4701	SUS26G*
* ID	0.25 mm



9771

9704

9707

Low Pressure Fittings (10 / pack) 1/4-28 UNF, rated to 1 MPa

P/N	Name
9771	1/8"HEX Flat Seal Fittings
9704	3.0 mm M6 Flat Seal Ferrules
9707	1/8" M6 Flat Seal Ferrules



9001

9003

9135

Medium Pressure Fittings (10 / pack) No.10-32 UNF, rated 20 - 40 MPa

P/N	Name
9001	Easy Fitt 10 mm
9003	Hex Fitt
9135	Hex Fitt Mini

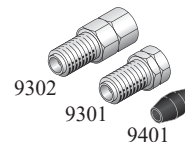

9302

9301

9401

High Pressure Fittings (10 / pack) No.10-32 UNF, rated to 60 MPa

P/N	Name
9302	1/16" DoubleLock Fitting L
9301	1/16" DoubleLock Fitting S
9401	1/16" DoubleLock Ferrule



9620

Ultra High Pressure Fittings No.10-32 UNF, rated to 140 MPa

P/N	Name
9620	Dual-Fitt SET (10 / pack)
9621	Dual-Fitting (10 / pack)
9623-05	Replacement Ferrule (5 / pack)
9623-10	Replacement Ferrule (10 / pack)



Injector Panel

P/N	Name
4515	Injector Panel

* The valve shown in the picture is not included and must be purchased separately.

*This cannot be attached to FLOM pumps. See page 10 for side panels for valve attachment to FLOM pumps.

Compact Valve Panel (V200, 201, 204, 239, V512)



P/N	Name
45150	Valve Panel

* The valve shown in the picture is not included and must be purchased separately.

*This cannot be attached to FLOM pumps. See page 10 for side panels for valve attachment to FLOM pumps.



Manual Valve V05

Manual Valve

A convenient manual valve for switching between flow paths.

Features

- Low torque design for easy switching
- Maximum pressure 35MPa (5075 psi)

Product Name	Manual Switching Valve
Product Number	V05
Type	Analytical 6-port
Path position	
Max pressure	35 MPa (5075 psi)
Wetted material	SUS , PEEK
Tube OD	1/16"
Path diameter	0.6 mm (0.024")
Thread size	No.10-32 UNF
Order Code	VH-V05



Compact Manual Valve
V200



Compact Manual Valve
V239

Compact Manual Valve

A convenient, ultra-compact valve for switching flow paths

Features

- Attach to the valve panel (sold separately) to allow operation from valve head side
- A line-up of 5 units to cover a wide variety of applications

Product Name	Compact Manual Valve	
Product Number	V200	V201
Type	Analytical 6-port	Analytical 3 port 2 way
Path position		
Max pressure	20 MPa (2900 psi)	20 MPa (2900 psi)
Wetted material	PEEK	PEEK
Tube OD	1/16"	1/16"
Path diameter	0.6 mm (0.024")	0.6 mm (0.024")
Thread size	No.10-32 UNF	No.10-32 UNF
Order Code	VH-V200	VH-V201

Product Name	Compact Manual Switching Valve		
Product Number	V204	V512	V239
Type	Analytical 1-2 port	Analytical 1-2 port	Analytical 1-2 port
Path position			
Max pressure	20 MPa (2900 psi)	30 MPa (4350 psi)	1 MPa (145 psi)
Wetted material	PEEK	SUS , PEEK	PEEK
Tube OD	1/16"	1/16"	3.0 mm or 1/8"
Path diameter	0.8 mm (0.03")	0.8 mm (0.03")	1.0 mm (0.04")
Thread size	No.10-32 UNF	No.10-32 UNF	1/4-28 UNF
Order Code	VH-V204	VH-V512	VH-V239

3. Degassing Units

We have redesigned our AG and BG Series units for trouble-free operation.
Consult our “Degassing Performance Comparison Chart” below to find the right unit for your application.



Gastorr AG-42

Gastorr AG-44

Product Name	Gastorr Solvent Degassing System	
Product Number	AG-42-01	AG-44-01
Channels	2	4
Internal volume	340 μ L	
Flow rate	\leq 10 mL/min	
Vacuum range	100 hPa fixed	
Thread size	1/4-28UNF	
Wetted material	Teflon™ AF*1, PFA, PPS	
Remote control	—	
Dimensions	108 (H) \times 70 (W) \times 240 (D) mm (excluding protuberances)	
Weight	Approx. 2.1 kg	
Power	AC 100 ~ 240 V (50 / 60 Hz) MAX 80 VA	
Order code	SGA-G3001	SGA-G3002

*1: Teflon™ AF is a registered trademark of the Chemours Corporation.
Note: cannot be used with fluorinated solvents.

Solvent Degassing System Gastorr AG Series

Redesigned high precision degassing system with improved self-cleaning function

Features

- Uses Teflon™AF tubing for minimal internal volume
- Self-cleaning function protects device interior
- CPU control achieves stable degassing
- Independent chamber design prevents solvent contamination
- Choose from 2 channel or 4 channel configurations

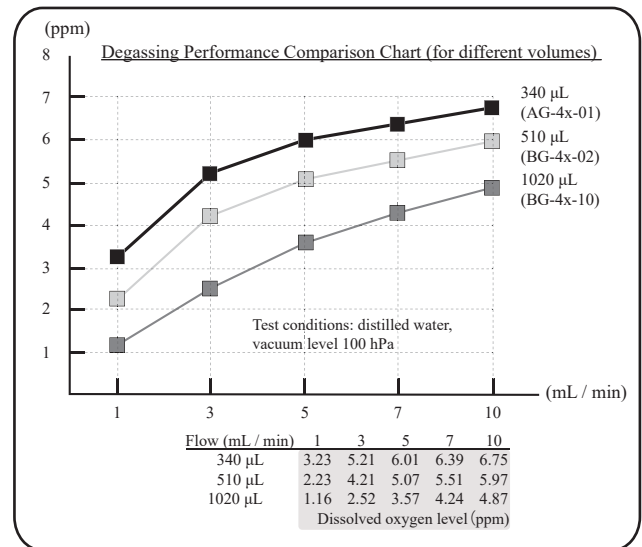

Note that degassing performance may vary depending on operating conditions.



Gastorr BG-42

Gastorr BG-44

Product Name	Gastorr Solvent Degassing System			
Product Number	BG-42-02	BG-44-02	BG-42-10	BG-44-10
Channels	2	4	2	4
Internal volume	510 μ L		1020 μ L	
Flow rate	\leq 10 mL/min			
Vacuum range	100 hPa fixed			
Thread size	1/4-28UNF			
Wetted material	Teflon™ AF*1, PFA, PPS			
Remote control	Input: — Output: Error			
Dimensions	108 (H) \times 70 (W) \times 240 (D) mm (excluding protuberances)			
Weight	about 2.1 kg			
Power	AC 100 ~ 240 V (50 / 60 Hz) MAX 80 VA			
Order code	SGA-G3003	SGA-G3004	SGA-G3005	SGA-G3006

*1: Teflon™ AF is a registered trademark of the Chemours Corporation.
Note: cannot be used with fluorinated solvents.

Solvent Degassing System Gastorr BG Series

A higher volume degassing system for even better degassing functionality

Features

- Uses Teflon™AF tubing for minimal internal volume
- Choose from 2 internal volumes to fit flow rate
- Self-cleaning function preserves device interior
- CPU control achieves stable degassing
- Independent chamber design prevents solvent contamination
- Choose from 2 channel or 4 channel configurations
- Real time display of chamber vacuum level (OLED display)



Gastorr FG-42

Solvent Degassing System Gastorr FG-42

Degassing system for fluorinated solvents

Features

- Meant for use with fluorinated solvents
- Self-cleaning function protects device interior
- CPU control achieves stable degassing
- Independent chamber design prevents solvent contamination

Product Name	Gastorr Solvent Degassing System	
Product Number	FG-42	
Channels	2	
Internal volume	10 mL	
Flow rate	≤ 5 mL/min	
Vacuum range	150 hPa fixed	
Thread size	1/4-28UNF	
Wetted material	PTFE, ETFE, PPS	
Remote control	Input: — Output: Error	
Dimensions	108 (H) × 70 (W) × 240 (D) mm (excluding protuberances)	
Weight	Approx. 2.3 kg	
Power	AC 100 ~240 V (50 / 60 Hz) MAX 80 VA	
Order code	SGA-G3008	



Gastorr PG-41P

Gastorr PG-42P

Solvent Degassing for Fractionating Applications Gastorr PG Series

Degassing systems with flow rates up to 50 mL/min for fractionating applications

Features

- Flow rates up to a max of 50 mL/min
- Self-cleaning function protects device interior
- CPU control achieves stable degassing
- Independent chamber design prevents solvent contamination
- Choose from 1 channel or 2 channel configurations
- Real time OLED display of chamber vacuum level

Product Name	Gastorr Solvent Degassing System for Fractionating	
Product Number	PG-41P	PG-42P
Channels	1	2
Internal volume	62.0 mL	
Flow rate	≤ 50 mL/min	
Vacuum range	150 hPa fixed	
Thread size	1/4-28UNF	
Wetted material	PTFE, ETFE, PEEK	
Remote control	Input: — Output: Error	
Dimensions	180 (H) × 90 (W) × 400 (D) mm (excluding protuberances)	
Weight	Approx. 5.0 kg	Approx. 6.0 kg
Power	AC 100 ~240 V (50 / 60 Hz) MAX 80 VA	
Order code	SGA-G3501	SGA-G3502

4. Reservoir Sensor



Sonic Reservoir Sensor SR-13

Sonic Reservoir Sensor SR-13

Non-contact liquid level sensor using sound

Features

- Monitors liquid levels in solvent bottles and waste tanks
- Liquid level displays
- Alarm sounds at danger level
- One-touch connection
- Control with RS232C protocol (option)

Product Name	Sonic Reservoir Sensor
Product Number	SR-13
Wetted material	Solvent probe: non-contact, Waste probe: PTFE
Remote control	Input : — Output: Error
Communication	RS232C (option)
Dimensions	115 (H) × 85 (W) × 80 (D) mm, excluding protuberances
Weight	Aprox. 0.7 kg
Power	DC 24V MAX 15W (AC adapter included)
Order Code	FA007-500



RESERVOIR SENSOR

Probes and Optional Accessories

SR-13 Accessories

P/N	Name
FD007-502	Solvent Probe
FD007-503	Waste Probe
FD007-504	Solvent Bottle
FD007-505	Waste Tank
FD007-506	RS232C Terminal



Solvent Probe



Waste Probe



Solvent Bottle



Waste Tank

5. Reactors



Reactor RT-11

Reactor RT-11

A chemical reaction chamber settable from 40° to 100° C

Features

- High accuracy temperature regulation
- Real-time display of internal temperature
- Tube cartridge for easy replacement
- Can set up to 10m of 1/16" tubing
- Overheating prevention function

Product name	Reactor
Product number	RT-11
Heat regulation	Block Reactor (Cartridge Style)
Temperature range	40 ~ 100 °C (when ambient temp is 25 °C)
Accuracy	±1.0 °C
Reaction tube*1	OD 1/16" × 10m × 1 tube
Safety feature	Thermostat (120 °C)
Remote control	Input : Conduction OFF, Release ON Output : Error
Dimensions	170 (H) × 110 (W) × 285 (D) mm, excluding protuberances
Weight	Approx. 3.5 kg
Power	AC 100 ~ 240 V (50 / 60 Hz) MAX 130 VA
Order code	SOV-K452

*1: PTFE tube (1/16" × 0.5mm × 10m) comes as standard accessory

Reactor RT-12

A chemical reaction chamber settable from 40° to 180° C



Reactor RT-12

Features

- High accuracy temperature regulation
- Real-time display of internal temperature
- Tube cartridge for easy replacement
- Can set up to 10m of 1/16" tubing
- Overheating prevention function

Product name	Reactor
Product number	RT-12
Heat regulation	Block Reactor (Cartridge Style)
Temperature range	40 ~ 180 °C (when ambient temp is 25 °C)
Accuracy	±1.0 °C
Reaction tube*1	OD 1/16" × 10m × 1 tube
Safety feature	Thermostat (200°C)
Remote control	Input : Conduction OFF, Release ON Output : Error
Dimensions	170 (H) × 110 (W) × 285 (D) mm, excluding protuberances
Weight	Approx. 4.5 kg
Power	AC 100 ~ 240 V (50 / 60 Hz) MAX 130 VA
Order code	SOV-K451

*1: PTFE tube (1/16" × 0.5mm × 10m) comes as standard accessory

6. OEM Products

From the start, our company has developed and manufactured OEM products which have been early sought by the major analytical instrument manufacturers. Our products are highly rated by users for their high accuracy flows, the result of our deep research into and development of flow process mechanisms.

Our device lineup promises high functionality, compact design, and low cost, and all products have been designed to be easy to use.

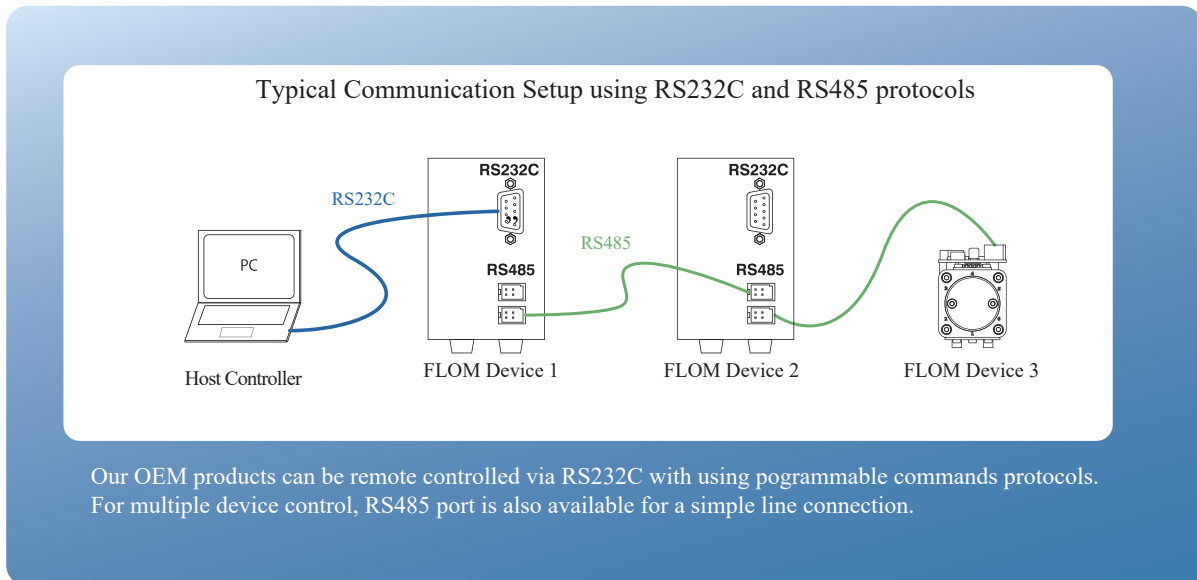

Note: analog signals can also be remotely connected.

<OEM> DP-11 Switching Delivery Pump



■ Dimensions

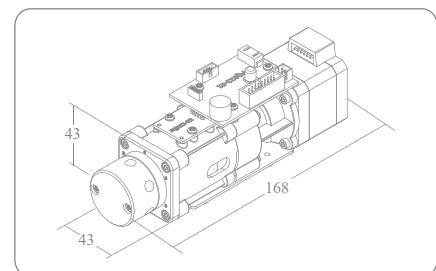

Product Name	Switching Delivery Pump
Part Number	DP-11A
Pump Modes	Measuring volume, Continuous flow, One-shot flow
Ports	6
Measuring Vol. Settings	0.001 ~ 9999.999 mL
Flow Rate Ranges	0.1 ~ 25.0 mL/min
Communication	RS232C , RS485 (between FLOM devices)
Power	DC 24 V , MAX 30 W

Note: see page 3 for the standalone version of this product.

Linear Drive Pulse Control Intelligent Pump <OEM> Intelligent Pump UI-22 series



Dimensions

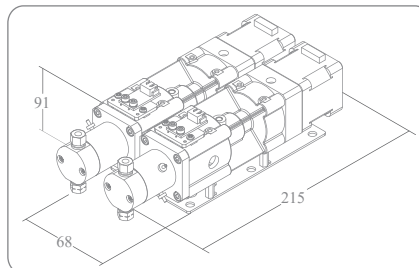

Typical Appearance



Product Name	Intelligent Pump
Product Number	UI-22A
Pumphead Material	SUS, PEEK, PCTFE
Flow Rate Ranges	Choose either 0.001 ~ 9.999 mL/min or 0.01 ~ 99.99 mL/min
Remote Control	Input: Pump On/Off, Output: Error
Communication	RS232C, RS485 (between FLOM devices)
Power	DC 24 V, MAX 50 W

Note: see page 7 for the standalone version of this product.

Solvent Degassing Units <OEM> Gastorr AG / BG series

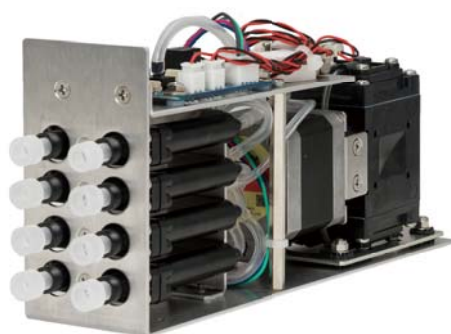

Dimensions

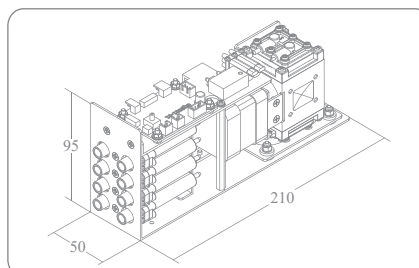

OEM UNIT

Product Name	Solvent Degassing Unit
Product Number	AG / BG-4xA
Channels	1 ~ 6 (pictured is 4-channel unit)
Wetted Material	Teflon™ AF *1, PFA, PPS
Internal Volume	340 μL or 510 μL
Remote Control	Input: —, Output: Error
Display	AG: —, BG: OLED Display
Power	DC 24 V, MAX 30 W

*1: Teflon™ AF is a registered trademark of the Chemours Corporation
Note: see page 16 for the standalone version of this product..

OLED Display

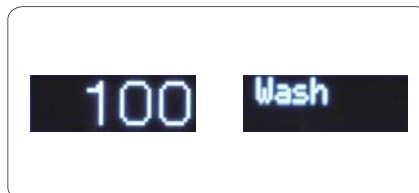

Auto Switching Valves <OEM> Auto Valve VA-21A series



Dimensions

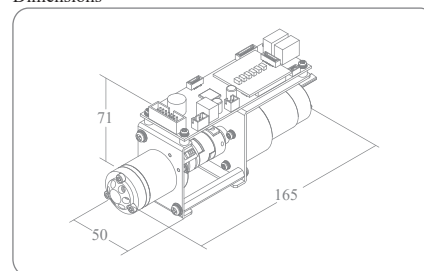

Valve Drive

Part Name	Auto Valve Unit
Part Number	VA-21A
Drive	DC gear motor drive
Switching Modes	2 position switching, rotary
Switching Speed	0.5 sec (when switching 60°)
Communication	Input: position change, set, reset Output: position error
Power	DC 24 V , MAX 50 W
Weight*1	Approx. 0.8 kg

*1: Weight given is only one example. Actual weight depends on the valvehead installed.

Valveheads (Contact Flom if you need valveheads with specs not shown in the graph below.)

Part Number	Type	Path Position	Max Pressure	Wetted Material	Tube OD	Thread Size	Path Diameter
VA-21A-601	6 Port		40 MPa (5800 psi)	SUS , PEEK	1/16"	No.10-32UNF	0.25 mm (0.01")
VA-21A-602			30 MPa (4350 psi)	PEEK , Ceramic	1/16"	No.10-32UNF	0.25 mm (0.01")
VA-21A-603			40 MPa (5800 psi)	SUS , PEEK	1/16"	No.10-32UNF	0.5 mm (0.02")
VA-21A-604			30 MPa (4350 psi)	PEEK , Ceramic	1/16"	No.10-32UNF	0.5 mm (0.02")
VA-21A-605			20 MPa (2900 psi)	SUS , PEEK	1/16"	No.10-32UNF	1.0 mm (0.04")
VA-21A-606			20 MPa (2900 psi)	PEEK , Ceramic	1/16"	No.10-32UNF	1.0 mm (0.04")
VA-21A-607			5 MPa (725 psi)	SUS , PEEK	3.0 mm or 1/8"	M8×1.25	2.0 mm (0.079")
VA-21A-608			5 MPa (725 psi)	PEEK , Ceramic	3.0 mm or 1/8"	M8×1.25	2.0 mm (0.079")
VA-21A-609	4 Port		40 MPa (5800 psi)	SUS , PEEK	1/16"	No.10-32UNF	0.5 mm (0.02")
VA-21A-610			30 MPa (4350 psi)	PEEK , Ceramic	1/16"	No.10-32UNF	0.5 mm (0.02")
VA-21A-611	1-2 Port (3-way valve)		40 MPa (5800 psi)	SUS , PEEK	1/16"	No.10-32UNF	0.5 mm (0.02")
VA-21A-612			30 MPa (4350 psi)	PEEK , Ceramic	1/16"	No.10-32UNF	0.5 mm (0.02")
VA-21A-613			5 MPa (725 psi)	SUS , PEEK	3.0 mm or 1/8"	M8×1.25	2.0 mm (0.079")
VA-21A-614	1-4 port rotary		5 MPa (725 psi)	PEEK , Ceramic	3.0 mm or 1/8"	M8×1.25	2.0 mm (0.079")
VA-21A-615			40 MPa (5800 psi)	SUS , PEEK	1/16"	No.10-32UNF	0.5 mm (0.02")
VA-21A-616			30 MPa (4350 psi)	PEEK , Ceramic	1/16"	No.10-32UNF	0.5 mm (0.02")
VA-21A-617	1-6 port rotary		40 MPa (5800 psi)	SUS , PEEK	1/16"	No.10-32UNF	0.5 mm (0.02")
VA-21A-618			30 MPa (4350 psi)	PEEK , Ceramic	1/16"	No.10-32UNF	0.5 mm (0.02")
VA-21A-619			5 MPa (725 psi)	SUS , PEEK	3.0 mm or 1/8"	M8×1.25	2.0 mm (0.079")
VA-21A-620	1-12 port rotary		5 MPa (725 psi)	PEEK , Ceramic	3.0 mm or 1/8"	M8×1.25	2.0 mm (0.079")
VA-21A-621			20 MPa (2900 psi)	SUS , PEEK	1/16"	No.10-32UNF	0.5 mm (0.02")
VA-21A-622			20 MPa (2900 psi)	PEEK , Ceramic	1/16"	No.10-32UNF	0.5 mm (0.02")
VA-21A-623	8-port		20 MPa (2900 psi)	SUS , PEEK	1/16"	No.10-32UNF	0.5 mm (0.02")

High Speed Auto Switching Valves <OEM> Auto Valve VF-02 series



Dimensions

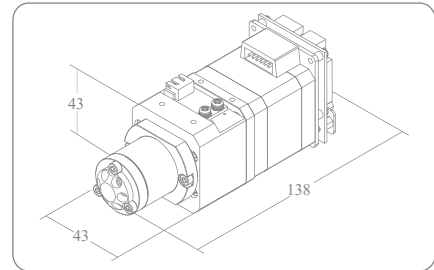

Valve Drive

Part Name	Auto Valve Unit
Part Number	VF-02
Drive	Direct drive with stepping motor
Switching Modes	2 position switching
Switching Speed	0.1 sec (when switching 60°)
Remote Control	Input: position change, reset Output: position error
Power	DC 24 V , MAX 50 W
Weight*1	Approx. 0.7 kg

*1: Weight given is only one example. Actual weight depends on the valvehead installed.

Valveheads (Contact Flom if you need valveheads with specs not shown in the graph below.)

Part Number	Type	Path Position	Max Pressure	Wetted Material	Tube OD	Thread Size	Path Diameter
VF-02-1002	6 Port		40 MPa (5800 psi)	SUS , PEEK	1/16"	No.10-32UNF	0.4 mm (0.016")
VF-02-1003			40 MPa (5800 psi)	PEEK (outer cover SUS)	1/16"	No.10-32UNF	0.4 mm (0.016")
VF-02-1005			20 MPa (2900 psi)	PEEK	1/16"	No.10-32UNF	0.4 mm (0.016")
VF-02-1103			40 MPa (5800 psi)	SUS , PEEK , Ceramic	1/16"	No.10-32UNF	0.4 mm (0.016")
VF-02-1104			40 MPa (5800 psi)	PEEK (outer SUS), Ceramic	1/16"	No.10-32UNF	0.4 mm (0.016")
VF-02-1036			40 MPa (5800 psi)	SUS , PEEK	1/16"	No.10-32UNF	0.25 mm (0.01")
VF-02-1037			40 MPa (5800 psi)	PEEK (outer cover SUS)	1/16"	No.10-32UNF	0.25 mm (0.01")
VF-02-1056			20 MPa (2900 psi)	PEEK	1/16"	No.10-32UNF	0.25 mm (0.01")
VF-02-1010	3 port 2-way		40 MPa (5800 psi)	SUS , PEEK	1/16"	No.10-32UNF	0.4 mm (0.016")
VF-02-1012			20 MPa (2900 psi)	PEEK	1/16"	No.10-32UNF	0.4 mm (0.016")
VF-02-1013	4 Port		40 MPa (5800 psi)	SUS , PEEK	1/16"	No.10-32UNF	0.4 mm (0.016")
VF-02-1015			20 MPa (2900 psi)	PEEK	1/16"	No.10-32UNF	0.4 mm (0.016")
VF-02-1040	8 Port		40 MPa (5800 psi)	SUS , PEEK	1/16"	No.10-32UNF	0.25 mm (0.01")
VF-02-1058			20 MPa (2900 psi)	PEEK	1/16"	No.10-32UNF	0.25 mm (0.01")
VF-02-1050	6 port vertical injection port		40 MPa (5800 psi)	SUS , PEEK	1/16"	No.10-32UNF	0.4 mm (0.016")
VF-02-1065			20 MPa (2900 psi)	PEEK	1/16"	No.10-32UNF	0.4 mm (0.016")

OEM UNIT

Pneumatic Drive Valve (Non-Electric) <OEM> Air Valve 415 series

Dimensions

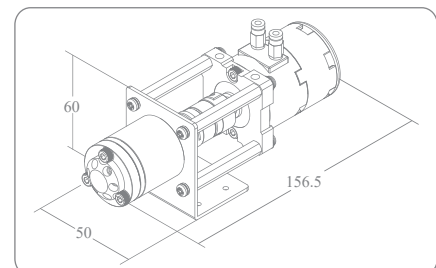

Part Name	Pneumatic Drive Valve
Part Number	415
Drive	Pneumatic Drive
Switching Mode	2 position switching
Air Tube OD*1	1/8"
Weight*2	Approx. 0.7 kg

*1: for tube sizes other than 1/8", contact FLOM.

*2: weight given is only one example. Actual weight depends on the valvehead installed.
Note: contact FLOM for valvehead specifications.

7. Tubing and Fittings

○SUS fittings for 1/16" tubing

Ultra-high Pressure Fittings (up to 140 MPa)

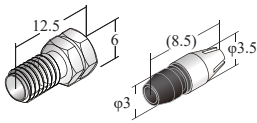

Name: Dual-Fitt SET
P/N: 9620
Material: SUS316, PEEK
Quantity: 10/pack



Name: Dual-Fitting
P/N: 9621
Material: SUS316
Quantity: 10/pack



Name: Replacement Ferrule
P/N: 9623-05 (5/pack), 9623-10 (10/pack)
Material: SUS316, PEEK
Quantity: 5/pack, 10/pack

Dual-Fitt

Reuseable high pressure joints

Features

- Reduces tube twisting
- Ferrule does not bite into tube, making reuse easy

Tightening Guide (Values will vary depending on tube type.)			
Sealing Torque	0.4 N•m	0.8 N•m	1.4 N•m
Pressure Rating	50 MPa (7252 psi)	100 MPa (14500 psi)	140 MPa (20300 psi)

High Pressure Fittings (up to 60 MPa)

DOUBLE LOCK Series (No.10-32 UNF, OD 1/16" tubing)

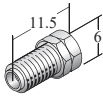

Name: 1/16" Double Lock Fitting S
P/N: 9301
Material: SUS316
Quantity: 10/pack

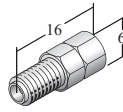

Name: 1/16" Double Lock Fitting L
P/N: 9302
Material: SUS316
Quantity: 10/pack

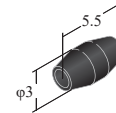

Name: 1/16" Double Lock Ferrule
P/N: 9401
Material: PEEK
Quantity: 10/pack

High Pressure Fittings (up to 40 MPa)

SUS Ferrule Type (No.10-32 UNF, OD 1/16" Tubing)

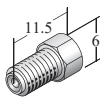

Name: 1/16" Fitting S
P/N: 9501
Material: SUS316
Quantity: 10/pack

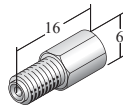

Name: 1/16" Fitting L
P/N: 9502
Material: SUS316
Quantity: 10/pack



Name: 1/16" Ferrule
P/N: 9601
Material: SUS316
Quantity: 10/pack

○ SUS Unions, Joints, and Tubing

SUS Unions

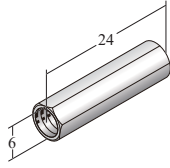

Name: Union
P/N: 9511
Material: SUS316
Thread: No.10-32 UNF
ID: 0.5 mm
Quantity: 1

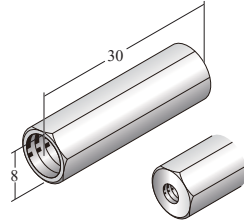

Name: 1/8"×1/16" Reducing Union
P/N: 9309
Material: SUS316
Thread: M8×1.25, No.10-32 UNF
ID: 1.0 mm
Quantity: 1

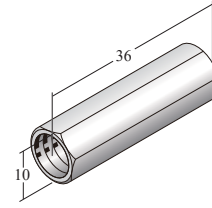

Name: 1/8" Union
P/N: 9330
Material: SUS316
Thread: M8×1.25
ID: 2.0 mm
Quantity: 1

SUS T-joints (for OD 1/16" Tubing)

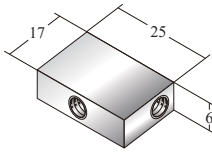

Name: T-joint 0.3
P/N: 9513-03
Material: SUS316
Thread: No.10-32 UNF
ID: 0.3 mm
Quantity: 1

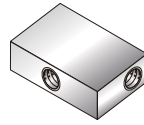

Name: T-joint 0.5
P/N: 9513-05
Material: SUS316
Thread: No.10-32 UNF
ID: 0.5 mm
Quantity: 1

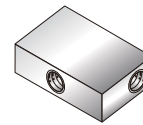

Name: T-joint 1.0
P/N: 9513-10
Material: SUS316
Thread: No.10-32UNF
ID: 1.0 mm
Quantity: 1

SUS T-joint (for OD 3.0 mm or 1/8" Tubing)

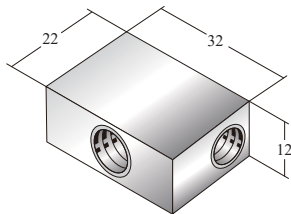

Name: 1/8" T-joint
P/N: 9313
Material: SUS316
Thread: M8×1
ID: 1.5 mm
Quantity: 1

Cross Joint (for OD 1/16" Tubing)

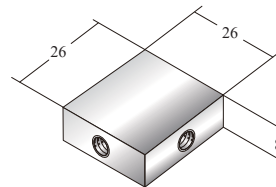

Name: Cross Joint 1.0
P/N: 9520
Material: SUS316
Thread: No.10-32 UNF
ID: 1.0 mm
Quantity: 1

SUS Tubing (OD 1/16" or 1/8")

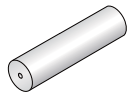

Name: SUS Tubing
P/N: 7021
Material: SUS316
OD: 1/16"
ID: 0.25 mm
Length: 10 m

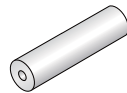

Name: SUS Tubing
P/N: 7022
Material: SUS316
OD: 1/16"
ID: 0.5 mm
Length: 10 m

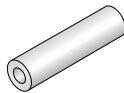

Name: SUS Tubing
P/N: 7023
Material: SUS316
OD: 1/16"
ID: 0.8 mm
Length: 10 m

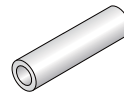

Name: SUS Tubing
P/N: 7024
Material: SUS316
OD: 1/16"
ID: 1.0 mm
Length: 10 m

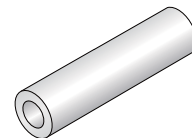

Name: SUS Tubing
P/N: 7025
Material: SUS316
OD: 1/8"
ID: 2.1 mm
Length: 2 m

○ PEEK Fittings for 1/16" Tubing

Medium Pressure Fittings (40 MPa)

DOUBLE LOCK PEEK Series (No.10-32 UNF, OD 1/16" Tubing)

Sealing Torque: 0.4 N·m (at pressure of 40 MPa)
Note: when using OD 1/16" ID 0.13 mm PEEK Tubing

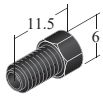

Name: 1/16" Double Lock Fitting S
P/N: 9411
Material: PEEK
Quantity: 10/Pack

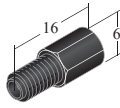

Name: 1/16" Double Lock Fitting L
P/N: 9412
Material: PEEK
Quantity: 10/Pack

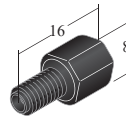

Name: 1/16" HEX Double Lock Fitting
P/N: 9415
Material: PEEK
Quantity: 10/Pack

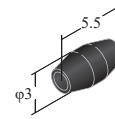

Name: 1/16" Double Lock Ferrule
P/N: 9401
Material: PEEK
Quantity: 10/Pack

DOUBLE LOCK PEEK Series (with PEEK Ferrule)



Name: 1/16" Double Lock Fitting S Set
P/N: 9411-9401
Material: PEEK
Quantity: 10 sets/Pack



Name: 1/16" Double Lock Fitting L Set
P/N: 9412-9401
Material: PEEK
Quantity: 10 sets/Pack

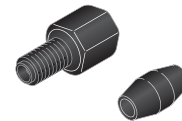

Name: 1/16" HEX Double Lock Fitting Set
P/N: 9415-9401
Material: PEEK
Quantity: 10 sets/Pack

Medium Pressure Fittings (20 ~ 40 MPa)

EASY FITT Series (No.10-32 UNF, OD 1/16" Tubing)

Sealing Torque: 0.3 N·m (at pressure of 40 MPa)
Note: when using OD 1/16" ID 0.13 mm PEEK Tubing

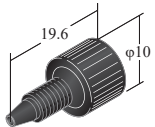

Name: Easy Fitt 10 mm
P/N: 9001
Material: PEEK
Quantity: 10/Pack

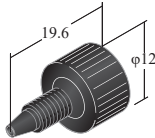

Name: Easy Fitt 12 mm
P/N: 9002
Material: PEEK
Quantity: 10/Pack

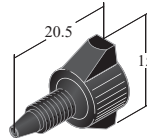

Name: Easy Fitt Type 2
P/N: 9130
Material: PEEK
Quantity: 10/Pack

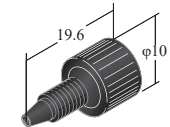

Name: Stop Fitt
P/N: 9004
Material: PEEK
Quantity: 10/Pack

HEX FITT Series (No.10-32 UNF, OD 1/16" Tubing)

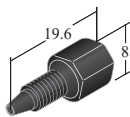

Name: Hex Fitt
P/N: 9003
Material: PEEK
Quantity: 10/Pack

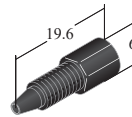

Name: Hex Fitt Mini
P/N: 9135
Material: PEEK
Quantity: 10/Pack

DOUBLE LOCK PEEK Series (No.10-32 UNF, OD 1/16" Tubing)

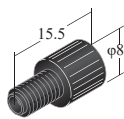

Name: 1/16" EASY8 Double Lock Fitting
P/N: 9416
Material: PEEK
Quantity: 10/Pack

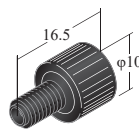

Name: 1/16" EASY10 Double Lock Fitting
P/N: 9413
Material: PEEK
Quantity: 10/Pack

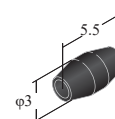

Name: 1/16" Double Lock Ferrule
P/N: 9401
Material: PEEK
Quantity: 10/Pack



Name: 1/16" EASY8 Double Lock Fitting Set
 P/N: 9416-9401
 Material: PEEK
 Quantity: 10 sets/pack



Name: 1/16" EASY10 Double Lock Fitting Set
 P/N: 9413-9401
 Material: PEEK
 Quantity: 10 sets/pack

○ Other Polymer Fittings for OD 1/16", 1/8", 3.0 mm, and 2.0 mm tubing

Low Pressure Fittings (up to 1 MPa)

FLAT SEAL Series (1/4-28UNF, OD 1/16" or 2.0 mm Tubing)

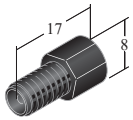

Name: 1/16" HEX Flat Seal Fitting
 P/N: 9773
 Material: PEEK
 Quantity: 10/pack

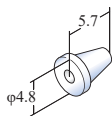

Name: 1/16" M6 Flat Seal Ferrule
 P/N: 9706
 Material: ETFE
 Quantity: 10/pack

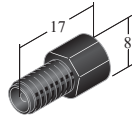

Name: 2.0 mm Flat Seal Fitting
 P/N: 9772
 Material: PEEK
 Quantity: 10/pack

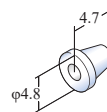

Name: 2.0 mm M6 Flat Seal Ferrule (Penetrating)
 P/N: 9755
 Material: ETFE
 Quantity: 10/pack

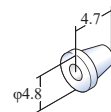

Name: 2.0 mm M6 Flat Seal Ferrule (Non-Penetrating)
 P/N: 9705
 Material: ETFE
 Quantity: 10/pack

FLAT SEAL Series (1/4-28UNF, OD 1/8" or 3.0 mm Tubing)

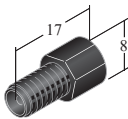

Name: 1/8" HEX Flat Seal Fitting
 P/N: 9771
 Material: PEEK
 Quantity: 10/pack

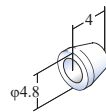

Name: 1/8" M6 Flat Seal Ferrule
 P/N: 9707
 Material: ETFE
 Quantity: 10/pack

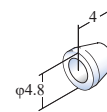

Name: 3.0 mm M6 Flat Seal Ferrule
 P/N: 9704
 Material: ETFE
 Quantity: 10/pack

FLAT SEAL Plug (1/4-28 UNF)

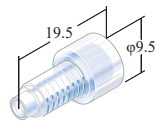

Name: Flat Seal Plug
 P/N: 9720P
 Material: PP
 Quantity: 10/pack

FLAT SEAL Series (M6×1, OD 2.0 mm Tubing)

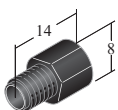

Name: 2.0 mm M6 Flat Seal Fitting
 P/N: 9752
 Material: PEEK
 Quantity: 10/pack

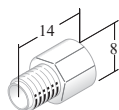

Name: 2.0 mm M6 Flat Seal Fitting
 P/N: 9732
 Material: POM
 Quantity: 10/pack

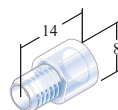

Name: 2.0 mm M6 Flat Seal Fitting
 P/N: 9762
 Material: PP
 Quantity: 10/pack

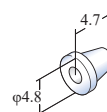

Name: 2.0 mm M6 Flat Seal Ferrule (Penetrating)
 P/N: 9755
 Material: ETFE
 Quantity: 10/pack

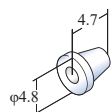

Name: 2.0 mm M6 Flat Seal Ferrule (Non-Penetrating)
 P/N: 9705
 Material: ETFE
 Quantity: 10/pack

FLAT SEAL Series (M6×1, OD 3.0 mm Tubing)

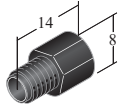

Name: 3.0 mm M6 Flat Seal Fitting
P/N: 9751
Material: PEEK
Quantity: 10/pack

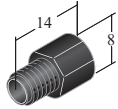

Name: 3.0 mm M6 Flat Seal Fitting
P/N: 9731
Material: POM
Quantity: 10/pack

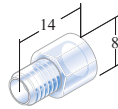

Name: 3.0 mm M6 Flat Seal Fitting
P/N: 9761
Material: PP
Quantity: 10/pack

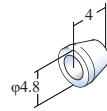

Name: 3.0 mm M6 Flat Seal Ferrule
P/N: 9704
Material: ETFE
Quantity: 10/pack

FLAT SEAL Series (M6×1, OD 1/8" or 1/16" Tubing)

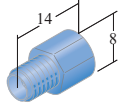

Name: 1/8" M6 Flat Seal Fitting
P/N: 9760
Material: PP
Quantity: 10/pack

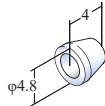

Name: 1/8" M6 Flat Seal Ferrule
P/N: 9707
Material: ETFE
Quantity: 10/pack

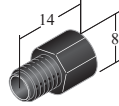

Name: 1/16" M6 Flat Seal Fitting
P/N: 9753
Material: PEEK
Quantity: 10/pack

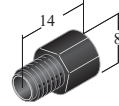

Name: 1/16" M6 Flat Seal Fitting
P/N: 9734
Material: POM
Quantity: 10/pack

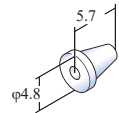

Name: 1/16" M6 Flat Seal Ferrule
P/N: 9706
Material: ETFE
Quantity: 10/pack

DOUBLE LOCK Series (M8×1, OD 3.0 mm or 1/8" Tubing)

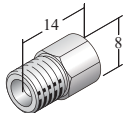

Name: 1/8" Double Lock Fitting
P/N: 9304
Material: SUS316
Quantity: 10/pack

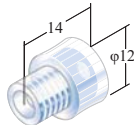

Name: 1/8" Double Lock Fitting
P/N: 9305
Material: PP
Quantity: 10/pack

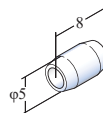

Name: 1/8" Double Lock Ferrule
P/N: 9402
Material: ETFE
Quantity: 10/pack

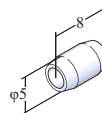

Name: 3.0 mm Double Lock Ferrule
P/N: 9405
Material: ETFE
Quantity: 10/pack

DOUBLE LOCK Series (M8×1.25, OD 3.0 mm or 1/8" Tubing)

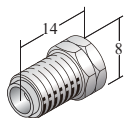

Name: 1/8" Double Lock Fitting
P/N: 9303
Material: SUS316
Quantity: 10/pack

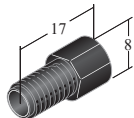

Name: 1/8" Double Lock Fitting
P/N: 9303P
Material: PEEK
Quantity: 10/pack

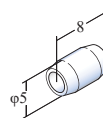

Name: 1/8" Double Lock Ferrule
P/N: 9402
Material: ETFE
Quantity: 10/pack

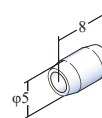

Name: 3.0 mm Double Lock Ferrule
P/N: 9405
Material: ETFE
Quantity: 10/pack

SUS Fitting (M8×1, OD 1/8" Tubing)

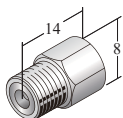

Name: 1/8" M8 Fitting
P/N: 9311
Material: SUS316
Quantity: 10/pack



Name: 1/8" Ferrule
P/N: 9321
Material: SUS316
Quantity: 10/pack

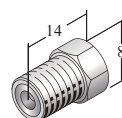

Name: 1/8" Fitting
P/N: 9306
Material: SUS316
Quantity: 10/pack



Name: 1/8" Ferrule
P/N: 9321
Material: SUS316
Quantity: 10/pack

SUS Fitting (M8×1.25, OD 1/8" Tubing)

○ Polymer Unions and Joints

Unions

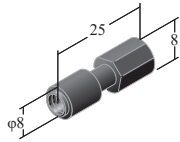

Name: Union
P/N: 9005
Material: PEEK
Thread: No.10-32 UNF
ID: 0.5 mm
Quantity: 1

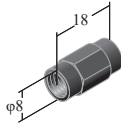

Name: Union
P/N: 9736
Material: POM
Thread: M6×1
ID: 1.0 mm
Quantity: 1

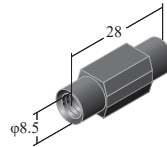

Name: Union
P/N: 9101
Material: PEEK
Thread: 1/4-28 UNF
ID: 1.0 mm
Quantity: 1

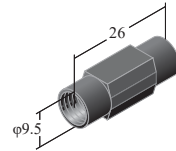

Name: Union
P/N: 9111
Material: PEEK
Thread: M8×1
ID: 1.0 mm
Quantity: 1

Reducing Unions

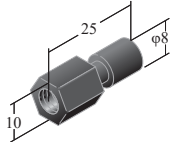

Name: Reducing Union
P/N: 9110
Material: PEEK
Thread: 1/4-28 UNF, No.10-32 UNF
ID: 1.0 mm
Quantity: 1

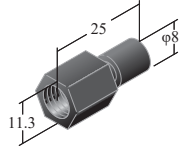

Name: Reducing Union
P/N: 9008
Material: PEEK
Thread: M8×1, No.10-32 UNF
ID: 1.0 mm
Quantity: 1

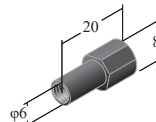

Name: Reducing Union
P/N: 9737
Material: POM
Thread: M6×1, No.10-32 UNF
ID: 1.0 mm
Quantity: 1

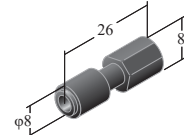

Name: Reducing Union
P/N: 9112
Material: PEEK
Thread: No.10-32 UNF, Syringe
ID: 1.0 mm
Quantity: 1

T-joints

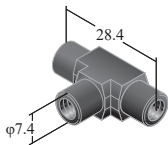

Name: T-joint
P/N: 9006
Material: PEEK
Thread: No.10-32 UNF
ID: 0.5 mm
Quantity: 1

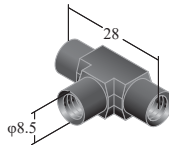

Name: T-joint
P/N: 9131
Material: PEEK
Thread: 1/4-28 UNF
ID: 1.0 mm
Quantity: 1

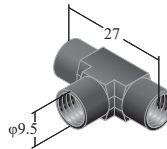

Name: T-joint
P/N: 9121
Material: PEEK
Thread: M8×1
ID: 1.0 mm
Quantity: 1

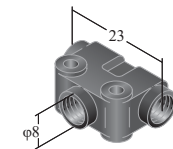

Name: T-joint
P/N: 9738
Material: POM
Thread: M6×1
ID: 1.0 mm
Quantity: 1

Multi-Thread T-joints

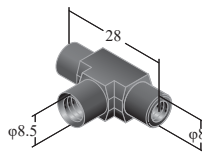

Name: Multi-Thread T-joint
P/N: 9108
Material: PEEK
Thread: No.10-32 UNF, 1/4-28 UNF
ID: 1.0 mm
Quantity: 1

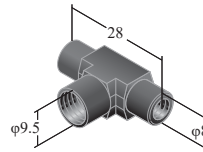

Name: Multi-Thread T-joint
P/N: 9107
Material: PEEK
Thread: No.10-32 UNF, M8×1
ID: 1.0 mm
Quantity: 1

Cross Joints

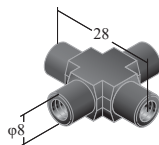

Name: Cross joint
P/N: 9007
Material: PEEK
Thread: No.10-32 UNF
ID: 0.5 mm
Quantity: 1

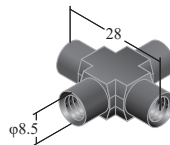

Name: Cross joint
P/N: 9109
Material: PEEK
Thread: 1/4-28 UNF
ID: 1.0 mm
Quantity: 1

○ETFE Fittings for 1/16", 1/8", 3.0 mm Tubing

ETFE Ferrule Type (No.10-32 UNF, OD 1/16" Tubing)

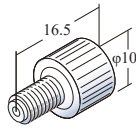

Name: 1/16" Fitting D
P/N: 9820D
Material: ETFE
Quantity: 10/pack



Name: 1/16" Ferrule D
P/N: 9821D
Material: ETFE
Quantity: 10/pack

FLAT SEAL Series (1/4-28 UNF, OD 3.0 mm or 1/8" Tubing)

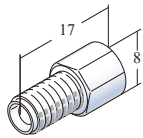

Name: 1/8" HEX Flat Seal Fitting D
P/N: 9822D
Material: ETFE
Quantity: 10/pack

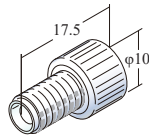

Name: 1/8" Flat Seal Fitting D
P/N: 9823D
Material: ETFE
Quantity: 10/pack

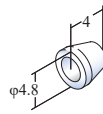

Name: 1/8" M6 Flat Seal Ferrule
P/N: 9707
Material: ETFE
Quantity: 10/pack

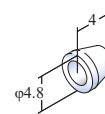

Name: 3.0 mm M6 Flat Seal Ferrule
P/N: 9704
Material: ETFE
Quantity: 10/pack

T-joints

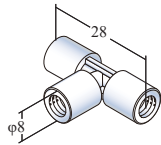

Name: T-joint D
P/N: 9824D
Material: ETFE
Thread: No.10-32 UNF
ID: 1.0 mm
Quantity: 1

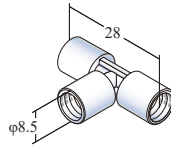

Name: T-joint D
P/N: 9825D
Material: ETFE
Thread: 1/4-28 UNF
ID: 1.0 mm
Quantity: 1

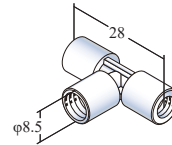

Name: Multi-thread T-joint D
P/N: 9826D
Material: ETFE
Thread: No.10-32 UNF, 1/4-28 UNF
ID: 1.0 mm
Quantity: 1

○ PEEK, PTFE, ETFE, PFA Tubing

PEEK Tubing (OD 1/16")



Name: PEEK Tubing
P/N: 5999
Line Color: Red
OD: 1/16"
ID: 0.13 mm
Length: 5 m
10 m



Name: PEEK Tubing
P/N: 6001
Line Color: Blue
OD: 1/16"
ID: 0.25 mm
Length: 5 m
10 m



Name: PEEK Tubing
P/N: 6002
Line Color: Orange
OD: 1/16"
ID: 0.50 mm
Length: 5 m
10 m



Name: PEEK Tubing
P/N: 6003
Line Color: Green
OD: 1/16"
ID: 0.75 mm
Length: 5 m
10 m



Name: PEEK Tubing
P/N: 60031
Line Color: Gray
OD: 1/16"
ID: 1.0 mm
Length: 5 m
10 m

PEEK Tubing (OD 1/8")

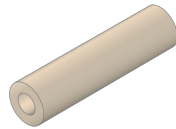

Name: PEEK Tubing
P/N: 6004A
OD: 1/8"
ID: 1/16"
Length: 10 m

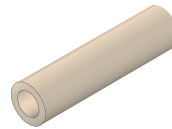

Name: PEEK Tubing
P/N: 60042A
OD: 1/8"
ID: 2.1 mm
Length: 10 m

PTFE Tubing

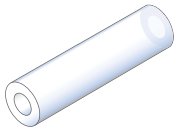

Name: PTFE Tubing
P/N: 7213
OD: 1/8"
ID: 1/16"
Length: 10 m

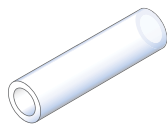

Name: PTFE Tubing
P/N: 7005
OD: 3.0 mm
ID: 2.0 mm
Length: 10 m



Name: PTFE Tubing
P/N: 7211
OD: 1/16"
ID: 0.25 mm
Length: 10 m



Name: PTFE Tubing
P/N: 7210
OD: 1/16"
ID: 0.50 mm
Length: 10 m



Name: PTFE Tubing
P/N: 7212
OD: 1/16"
ID: 0.80 mm
Length: 10 m



Name: PTFE Tubing
P/N: 7215
OD: 1/16"
ID: 1.0 mm
Length: 10 m

ETFE Tubing



Name: ETFE Tubing
P/N: 7009
OD: 1/16"
ID: 0.20 mm
Length: 10 m



Name: ETFE Tubing
P/N: 7010
OD: 1/16"
ID: 0.30 mm
Length: 10 m



Name: ETFE Tubing
P/N: 7011
OD: 1/16"
ID: 0.50 mm
Length: 10 m



Name: ETFE Tubing
P/N: 7012
OD: 1/16"
ID: 0.80 mm
Length: 10 m



Name: ETFE Tubing
P/N: 7013
OD: 1/16"
ID: 1.0 mm
Length: 10 m

PFA Tubing



Name: PFA Tubing
P/N: 7103
OD: 2.0 mm
ID: 1.0 mm
Length: 10 m

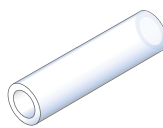

Name: PFA Tubing
P/N: 7104
OD: 3.0 mm
ID: 2.0 mm
Length: 10 m

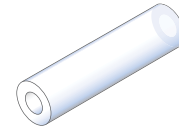

Name: PFA Tubing
P/N: 7105
OD: 1/8"
ID: 1/16"
Length: 10 m

8. Other Components

○ Filters

Solvent Filters

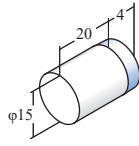

Name: Suction Filter
P/N: 8810
Pore Size: 20 μm
Connection: OD 1/8", 3.0 mm Tubing
Material: PTFE, PCTFE
Quantity: 1

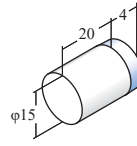

Name: Suction Filter
P/N: 8811
Pore Size: 20 μm
Connection: OD 1/16" Tubing
Material: PTFE, PCTFE
Quantity: 1

Solvent Filters (Inline)

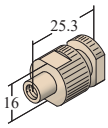

Name: PEEK Inline Filter
P/N: 8502
Pore Size: 5 μm
Connection: No.10-32 UNF
Material: PEEK
Quantity: 1

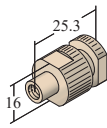

Name: PEEK Inline Filter
P/N: 8501
Pore Size: 10 μm
Connection: No.10-32 UNF
Material: PEEK
Quantity: 1



Name: PEEK Frit
(Inline Filter Replacement)
P/N: 8512
Pore Size: 5 μm
Material: PEEK
Quantity: 5



Name: PEEK Frit
(Inline Filter Replacement)
P/N: 8511
Pore Size: 10 μm
Material: PEEK
Quantity: 5

○ Solvent Bottles



Name: Solvent Bottle
P/N: 9841
Capacity: 1000 mL
Cap Type: 9851 Bottle Cap
Quantity: 1



Name: Solvent Bottle
P/N: 9842
Capacity: 500 mL
Cap Type: 9851 Bottle Cap
Quantity: 1



Name: Bottle Cap
P/N: 9851
Type: GL45 (for Schott Solvent Bottles)
Tubing OD can be 1/16", 1/8", 3.0 mm, 2.0 mm
Quantity: 1

○ Tube Cutters



Name: PEEK Tube Cutter
P/N: 9830
Quantity: 1



Name: SUS Tube Cutter
P/N: 9831
Quantity: 1

SUS

Stainless Steel. The material is mainly steel, but is corrosion resistant due to the chromium alloy, which forms a chromium oxide layer on the surface. Since it cannot be corroded by organic solvents and is highly pressure resistant, it is commonly used in pump heads, valve stators, tubing, fittings, and HPLC columns.

PEEK

Abbreviation for the plastic, polyetheretherketone. Exhibits superlative chemical and mechanical resistance properties. Since it has much higher resistance than other high polymer materials, all of which are inferior to stainless steel in this respect, it is used in everything from pump heads and pump rotor seals to tubing and fittings. Especially good in analytical applications of ionic substances or certain solvents which can corrode metal.

PTFE

Abbreviation of Polytetrafluoroethylene, a material exhibiting extremely high chemical resistance. Resistant to a wide variety of organic solvents and strongly acid/alkaline solutions, used as tubing in degassing units and in standard tubing and fitting products. However, because of its weak mechanical properties, it should only be used in low-pressure applications.

PCTFE

Abbreviation of Polytetrafluoroethylene, a material exhibiting extremely high chemical resistance. Resistant to a wide variety of organic solvents and strongly acid/alkaline solutions, used as tubing in degassing units and in standard tubing and fitting products. However, because of its weak mechanical properties, it should only be used in low-pressure applications.

ETFE

Abbreviation of Ethylene Tetrafluoroethylene. This material offers a good balance between chemical and mechanical resistance, and ease of formation. Used in a wide variety of tubing applications.

PFA

Abbreviation of Perfluoroalkoxy alkane. Usually combined with Tetrafluoroethylene. Close to the chemical resistance of PTFE but much easier to form, so used in specialty components where PTFE is difficult to work with.

Teflon™ AF

This is an amorphous polymer that, except for specialty fluorocarbon polymers, matches PTFE in its high chemical resistance. Since it has extremely high gas permeability compared to other fluorocarbon polymers, it is extremely useful as degassing tubing inside degassing units. Teflon is a registered trademark of the Chemours Company (USA).

FFKM

Abbreviation of the elastomeric form of poly(tetrafluoro ethylene) or PTFE. This rubber-like substance exhibits very high chemical resistance, so when both chemical resistance and high elasticity are required, this materials is often chosen.

UHMW-PE

Abbreviation of Ultra High Molecular Weight Poly Ethylene. This high molecular weight polymer shows high flexibility and strong mechanical properties and is often used in pump plunger seals which require both chemical and abrasion resistance.

PPS

Abbreviation of Polyphenylene sulfide. Considered by some a “super engineering plastic” because of its high performance in chemical and mechanical resistance as well as in ease of molding. Often used in the vacuum chambers of degassing devices.

POM

Abbreviation of Polyoxymethylene, widely referred to as Polycetal. This plastic is a well-balanced blend of chemical resistance, strength, slidability, abrasion resistance and cost performance. Widely used in fittings.

MEMO



Visit our website at <http://www.flom.co.jp> for the latest news about our products, and to download our latest catalog and technical specification sheets.



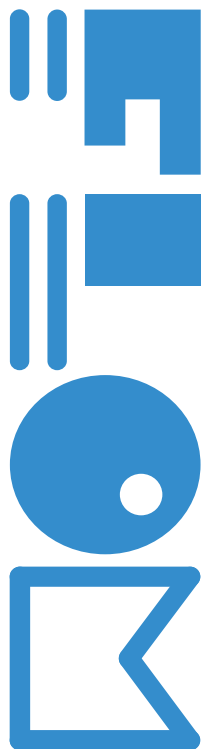

FLOM Corporation

5-32-10 Shinmachi, Ome City,
Tokyo 198-0024 Japan
TEL: +81-428-30-7454
FAX: +81-428-30-7452



BGB GC|LC
MS|CE

www.bgb-shop.com

Switzerland BGB Analytik AG • Rohrmattstrasse 4 • 4461 Böckten • Phone +41 61 991 00 46 • Fax +41 61 991 00 25 • sales@bgb-analytik.com
Benelux BGB Analytik Benelux B.V. • Drielandendreef 42 • 3845 CA Harderwijk • Phone +31 341 700270 • Fax +31 341 700271 • sales.benelux@bgb-analytik.com
France BGB Analytik France S.A.S. • 81 Vie de l'Etraz • 01630 St. Jean de Gonville • Phone +33 450 488567 • Fax +33 450 562378 • sales.fr@bgb-analytik.com
Germany BGB Analytik Vertrieb GmbH • Mühlestraße 1 • 79539 Lörrach • Phone +49 7621 5884270 • Fax +49 7621 5884289 • sales.de@bgb-analytik.com